

X-Habitation (X-Hab) Deployable Greenhouse
Environmental Design Team

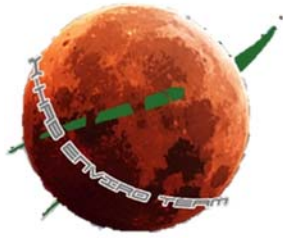

Greenhouse Systems for Deployment on Mars

Senior Design Project
Biosystems & Agricultural Engineering
Final Project Report

Submission Date 05/7/2015

Bryant Z. Bennett

Jonathan C. Overton

Matthew B. Rogers

Peter Q. Storm

Partnered with: National Aeronautics and Space Administration

Table of Contents

1. Statement of Problem	3
2. Customer Requirements	4
3. Literature Review and Relevant Patents	6
4. Engineering Specification	7
5. Design Selection	8
6. Risk Analysis	18
8. Environmental and Societal Impact	30
9. Design Summary	31
10. Acknowledgements	33
11. References Consulted	35
12. Appendices	39

List of Tables

Table 1: Atmosphere Requirements	7
Table 2: Plants considered for use in the Green Wings.....	14
Table 3: The planting schedule for each GreenWing.....	17
Table 4: Budget for Grow Bed Analog.....	22
Table 5: Testing results for seed germination	23
Table 6: Cost of Analog Projects	39

List of Figures

Figure 1: Smart Fertilizer GUI displaying the potential chemicals to create a nutrient solution and the nutrient data for a plant	9
Figure 3: Overview of nutrient solution recirculation system.	12
Figure 2: Overview of nutrient solution recirculation system and associated instruments and controls..	12
Figure 4: Germination of lettuce seeds in a coffee filter	13
Figure 5: Shows the RVI for each of the leafy greens	15
Figure 6: Shows the RVI for each of the considered cool season crop.....	15
Figure 7: Shows the RVI for each of the warm season crops	16
Figure 8: Shows the average RVI of each of the selected plant species	16
Figure 9: The constructed analog grow bed at the ARS Greenhouse.....	22
Figure 10: Aeroponics systems housed in the GreenWing analog	24

Partnered with: National Aeronautics and Space Administration

Figure 11: Nutrient solution instrumentation housed in the analog..... 27

Figure 12: The two LCD displays for the Environmental Sensors that were installed in the full-scale analog..... 2728

Figure 13: Desktop view of lighting system before analog installation 29

1. Statement of Problem

In conjunction with the Aerospace Engineering design team, the systems and structures necessary to supplement the diet of a four-man mission to Mars for at least 500 days has been designed. The systems and structures were designed with future additions in mind, allowing for modular additions and extended use. In all aspects of the project, safety was held paramount. On Mars, a systems failure will almost undoubtedly result in loss of life, equipment, and investment. Ensuring that all systems are reliable and properly functioning has been the top priority of the team. With a four-man team, all man-hours will be crucial to the development of knowledge pertaining to Mars, and more time spent operating and maintaining food production systems will result in less available time for scientific research or other advancement. Automation systems were developed in conjunction with BAE 3023 (Instrumentation and Controls in Biosystems Engineering). The selection of a biological production system to fill the greenhouse design of the NASA X-Hab Greenhouse Structures Team (Aerospace Engineering) was conducted by the NASA X-Hab Environmental Team (Biosystems Engineering). The plants selected are sufficient to supplement a four-man crew on the Moon, Mars, or similar bodies. In addition, the rotation of planting and harvesting is sufficient to provide continuous production for 500 days and has been optimized to require as little space as possible.

2. Customer Requirements

2.1. Project Overview and System Design Review (SDR)

The National Aeronautics and Space Administration (NASA) requested that the design provide a supplementary diet for a Mars or lunar mission of up to 500 days with a crew of 4 to 6 people. NASA stipulated that non-essential foods such as lettuce, tomato, berries, and spices (Raymond Wheeler, NASA, personal communication, September 19, 2014) be selected to provide fresh produce for astronauts. Crops were selected to reduce processing, maintenance, and nutrient requirements. NASA further stipulated that a hydroponic growth system was their preferred option. NASA stated that 75 m² would be the maximum allowed area per crew member for plant growth (Raymond Wheeler, NASA, personal communication, September 19, 2014). Lastly, NASA stated that water would likely need to be recycled from evapotranspiration to ensure a sustainable rate of water consumption (Raymond Wheeler, NASA, personal communication, September 19, 2014).

2.2. Preliminary Design Review (PDR)

While presenting the PDR, the NASA scientists provided the team additional requirements, expectations, and concerns about the project progress. Dr. Massa suggested that the Martian atmosphere was cold enough to be used to condense water loss to evapotranspiration in the greenhouse. These systems could be incorporated into the wall structure of the GreenWing. Dr. Wang also suggested that sterilization systems be put in place to reduce the chances of microbial or insect infection of plant species. Special care would be needed to prevent the formation of biofilms, which would lower mass transfer coefficients and are difficult to remove without scrubbing.

2.3. Critical Design Review (CDR)

During the CDR, NASA scientists were updated with a progress report over what had developed since the PDR as well as presented finalized plans for the space rated system design. In addition, NASA was given new information concerning future design plans. The aeroponic system was reviewed, and the crops selected were given to NASA and justified by a resource viability index (see Figures 7-10). A two-part nutrient solution was reviewed. The nutrient solution allows the mixture to be adjusted based on pH and electroconductivity. Part A of the solution contains cations and Part B contains anions. The pH and electroconductivity will be monitored and adjusted accordingly by adding either Part A or Part B solution. In addition to the nutrient solution, temperature and lighting will also be monitored to allow suitable growing conditions. Finally, germination plans were reviewed. Seeds will be germinated using coffee filters for easy germination in the aeroponic system. The filter will house the seed and keep the seed moist without letting the seed drown. NASA gave the design team approval to complete the analog test plans.

2.4. Checkpoint #1

During the checkpoint review, NASA ensured that the X-Hab team was making substantial progress on the construction of analogs and other design models. NASA found the design progress to meet expectations, and expressed pleasure that progress on the construction of analogs matched the timeline proposed in the CDR.

3. Literature Review and Relevant Patents

Past studies have focused on the growth of plants in low light, low pressure, and low nutrient media. A few other studies have focused on the creation of a bioregenerative life support system (BLSS). BLSS creates a loop using the O₂ produced by plants via photosynthesis which is then consumed by humans who in return produce CO₂ via respiration for the plants. However, considering the proposed floor plan with a separate greenhouse and living area, the mass balance loop will be harder to close, as humans will not be consuming O₂ and producing CO₂ in the same space as the plants. A few patents addressed the germination of seeds for an aeroponic system. Most patents focused on porous materials to hold moisture close to the seed to induce germination.

4. Engineering Specification

4.1. GreenWing Atmosphere Requirements

The atmospheric conditions required for plant growth are shown in Table 1. The structures team designed the necessary environmental control systems to maintain these conditions in each wing.

Table 1: Atmosphere Requirements

Oxygen Partial Pressure (kPa) (MAE)	> 5
Oxygen (% at atmospheric conditions) (MAE)	13-50
Carbon Dioxide (ppm) (OSHA)	< 1000
Atmospheric Temperature (°C)	18-24

4.2. Space Availability

NASA expressed a desire to make the footprint of the whole system as close to 75 m² per person as possible. Based on this specification, the total system area is no more than 300 m². The structures group provided a structure that maximizes the area available for growing systems and controls while remaining within NASA requirements.

5. Design Selection

5.1. Aeroponic and Growing System

5.1.1. Aeroponic System

An aeroponic system can be constructed on both small and large scales. Each system will have separate nutrient compositions to optimize growth. Due to the large plant selection outlined below, one smaller system with separate nutrient compositions will be required for each GreenWing. For each given system, there are multiple system components required for pressure and stream regulation, plant support, and nutrient distribution.

To choose a proper nutrient solution, individual plant needs must be met. Many commercial products currently exist that can easily be combined for individual plants. However, there is a possibility that these premixed solutions may not fully cover the range of nutrients required for all plants.

Nutrient solutions must be provided in at least two parts; one part containing anions and the other cations. If the nutrient solutions are not separated prior to mixing, there is a high chance that the contained elements and compounds will react and cause parts of the solution to precipitate, rendering some of the nutrients unavailable to plants due to the newly formed insoluble compounds. A selection of commercial premixed nutrient solution parts A & B exist on the market for hydroponic setups.

To best optimize the fertilizers to be used within the mixing tank, commercial nutrient solution calculators exist. Figure 1 shows part of the GUI for Smart Fertilizer, a commercially available software package for creating fertilizer solutions for different crops at different stages in their life. Using this or similar software will

The screenshot displays the 'Tanks' section of the Smart Fertilizer GUI. It features three tanks (Tank 1, Tank 2, and Tank 3) with their respective fertilizer distributions. The 'Insert Target Values' section shows a table of nutrient targets for an Apricot crop.

Tanks Distribution

Tank	Fertilizer Name	Volume/M... Unit
Tank 1	Zn-EDTA 13%	0.53 Kg
	Fe-DTPA 11%	1.02 Kg
	Calcium Nitrate	48.39 Kg
Tank 2	Mono potassium Phosphate (M.K.P)	4.73 Kg
Tank 3	Magnesium Sulphate	22.51 Kg
	Potassium Sulphate	30.45 Kg

Insert Target Values

Application Frequency: 180.00 days

Select Units: kg/ha

N Forms				P	K	Ca	Mg	S	B	Fe	Mn	Zn	Cu	Mo	Ita	HCO3	Cl
Total N	N-NO3	N-NH4	N-NH2														
120.00				17.02	230.71	158.54	38.02		0.300	2.000	0.800	0.350	0.040				

Crop Information

Name: Apricot
 Variety: General
 Plants/ha: 0
 Fert. Application Method: By/AreaMethod
 Growing Method: General
 Yield Goal: 40.00 MT/ha
 Stage / Recommendation: Total Nutrient Uptake

Figure 1: Smart Fertilizer GUI displaying the potential chemicals to create a nutrient solution and the nutrient data for a plant

ensure proper nutrient management for all plants. Furthermore, excessive salts and certain nutrients can harm plants. Electrical conductivity measurements can estimate the salt concentrations and are a viable means to monitor the quality of the nutrient solution.

To properly distribute water and nutrients to the plant roots, high-pressure nozzles are employed to distribute atomized water to the plant roots (10-50 μm droplets).

Atomized water droplets have been found to significantly increase nutrient and water uptake rates when compared to larger droplets in previous studies. However, atomizing water droplets requires high pressure systems, ranging between 80 to 150 psi. While lower pressure aeroponic systems exist, they are unable to create atomized droplets. The primary challenge faced with this design choice is designing a high-pressure system, which requires a more robust design that allows for fewer errors within the system and will be more likely to fail due to any breaches.

To effectively run a high-pressure aeroponic system, the piping system must maintain an elevated pressure for the entire duration of each watering period. A hydraulic accumulator (bladder tank) will be used to maintain pressure in the lines, while a high-pressure water pump will be used to draw the nutrient solution from a non-pressurized reservoir and into the hydraulic accumulator. Using an accumulator ensures the high-pressure water pump does not need to run continuously to maintain pressure within the system. High-pressure tubing and piping will house the high-pressure nozzles and move nutrient solution to the plants.

Once the nutrient solution has been sprayed on the plant roots, a collection system is required to collect excess nutrient solution and return it to the nutrient solution reservoir. To reduce evaporation and maximize solution recollection while also reducing leaks, the sprayer nozzles and root systems will be contained within a water-tight system. This system will primarily employ gravity to drain water from the containers and into the nutrient solution reservoir.

To prevent foreign objects from entering the reservoir, in-line low-pressure filters will be installed between the collection system and the reservoir, and in-line high-

pressure filters will be installed between the reservoir and the nozzles to prevent any nozzles from becoming clogged. Pressure relief valves will be incorporated to reduce the potential for pipe failure caused by high pressure due to control system malfunction. A full schematic of the setup is shown in Figure 2. A control system will be developed to properly pressurize and refill the accumulator with the nutrient solution. Solenoids will be used to turn the spray nozzles on and off according to a plant feeding schedule. Other necessary systems, such as returning the solution to the reservoir from the collection system, will be added as the design progresses.

A schematic including some of the required aspects of the control system is shown in Figure 3. Furthermore, the quality of the nutrient solution (pH and total dissolved solids) will be constantly monitored to ensure the stability of the system, both from a nutrient and mechanical standpoint, as discussed earlier.

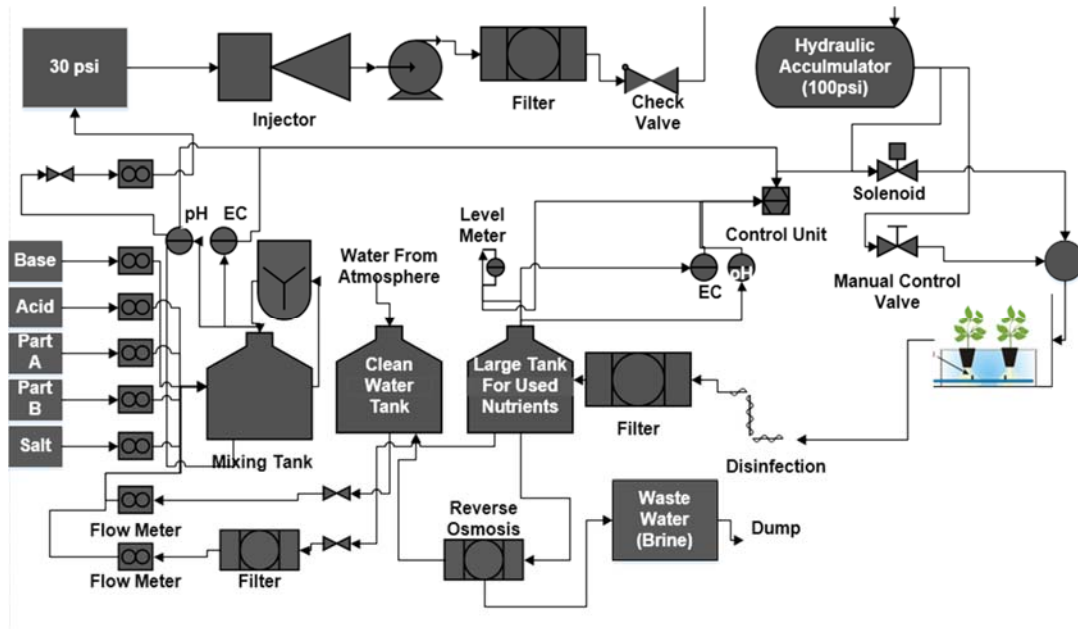

Figure 2: Overview of nutrient solution recirculation system and associated instruments and controls.

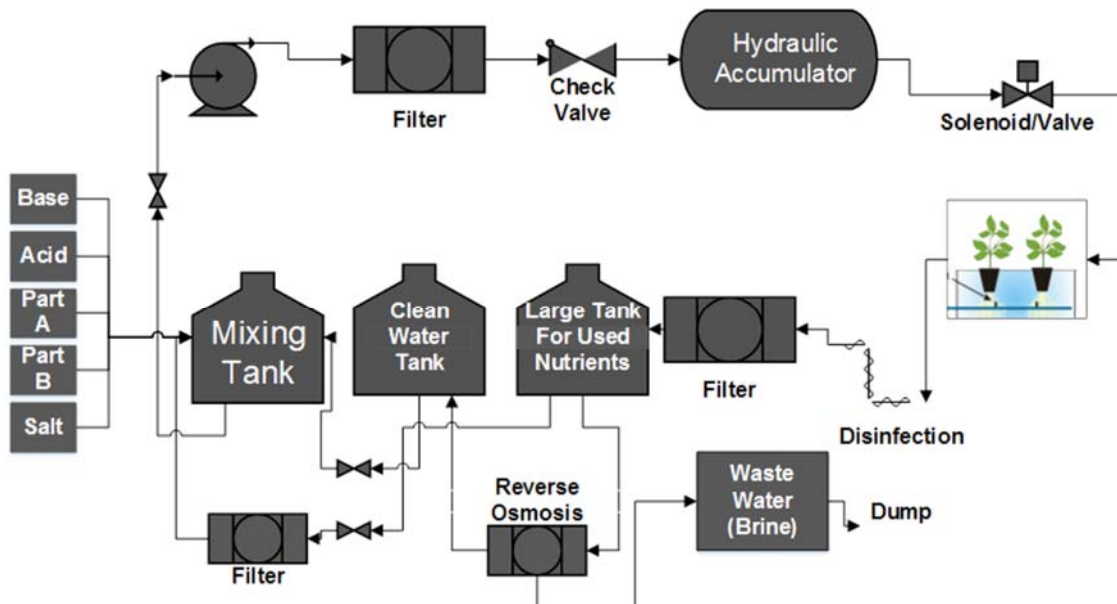

Figure 3: Overview of nutrient solution recirculation system.

5.1.2. Germination

Germination will be performed using moist coffee filters housed in plastic freezer bags. This method has been shown to be functional as seen in Figure 4. After 2 weeks of germination crops will be transplanted into the sleeves in the aeroponics system.



Figure 4: Germination of lettuce seeds in a coffee filter

5.1.3. Plant Selection

A wide selection of vegetables and fruits were first selected from a pool of plants

Figure 5: Overview of nutrient solution recirculation system and the associated instruments and controls.

pool of plants able to be grown in these systems, plants that are complimentary to one another when prepared for consumption were considered. Table 2 shows the crops that were considered for use in the GreenWings.

Table 2: Plants considered for use in the Green Wings

Leafy Greens	Lettuce, Spinach, Chard
Warm and Cool Season Vegetables	Broccoli, Cauliflower, Carrots, Green Onion, Cucumber, Radish, Snap Peas, Green Beans, Okra
Fruits/Berries	Tomatoes, Strawberries, Blackberries

5.1.4. Resource Viability Index

To assist with plant selection and prioritization, a rating system was created. Five plant characteristics were selected to make design selections: Plant yield, nutritional needs, daily water required, temperature range, and daily maintenance required. A graph was created for each plant that plotted the characteristics on the y-axis and the rating for each plant that ranged from 1 to 5 on the x-axis. A score of 1 is a poor rating, while a rating of 5 is high. A plant with all characteristics above 3 is considered ideal and therefore the plant with the most characteristics greater than 3 is considered the best option. This graphing method creates a visual representation of how close to ideal a given plant species is. Figures 9, 10, and 11 show the graphs created for each of the plant categories. Using the RVI score, the plants selected were lettuce, spinach, carrots, onions, cucumbers, radishes, snap peas, strawberries, and blackberries. Figure 12 shows the average RVI scores in each category for the selected plants.

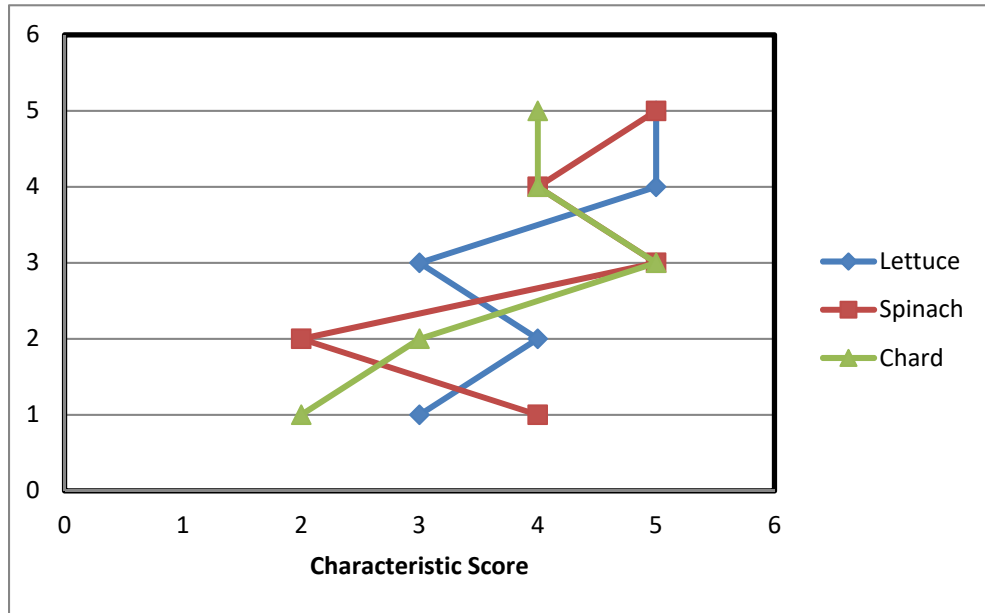

Figure 5: Shows the RVI for each of the leafy greens

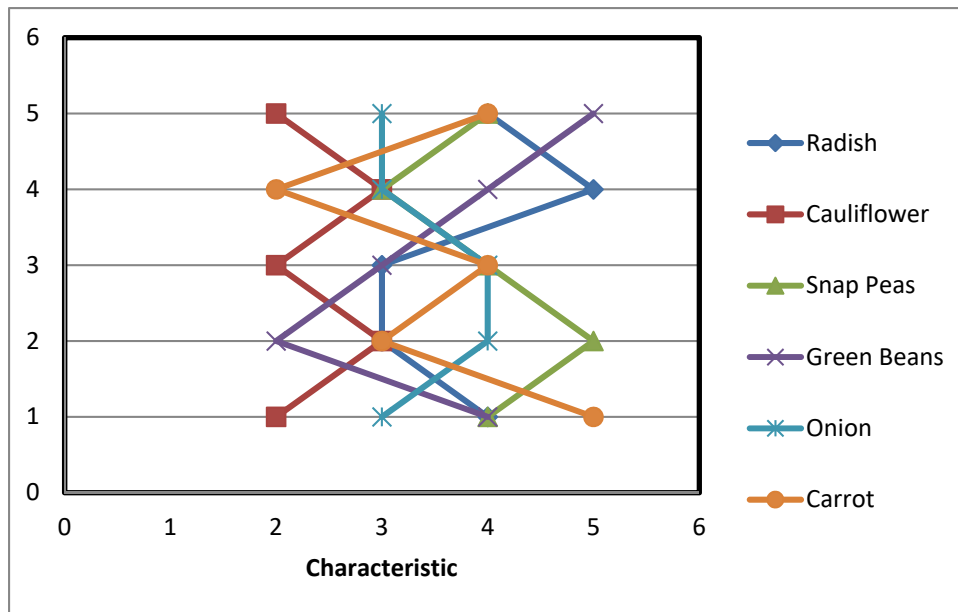

Figure 6: Shows the RVI for each of the considered cool season crop

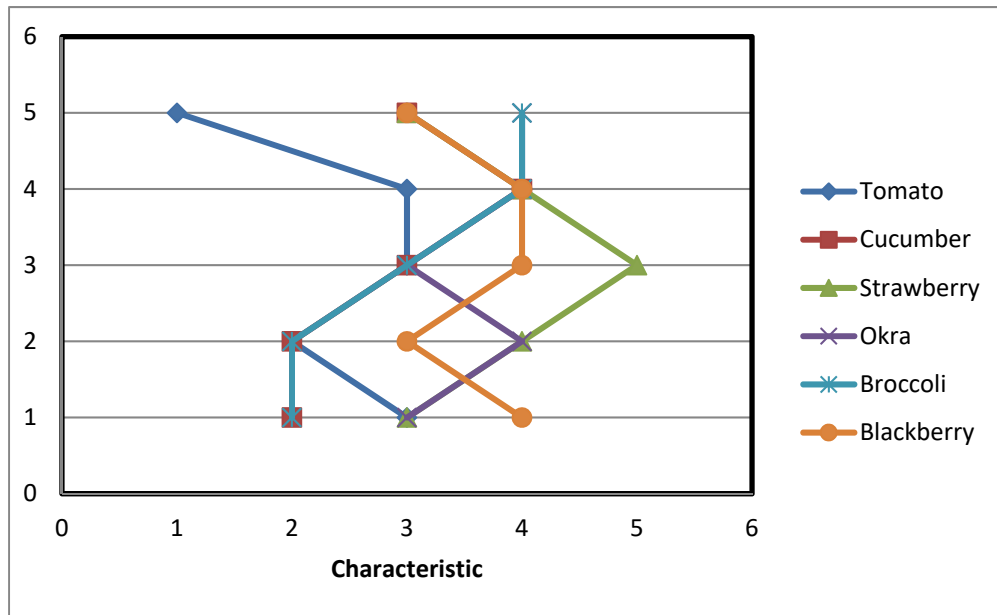

Figure 7: Shows the RVI for each of the warm season crops

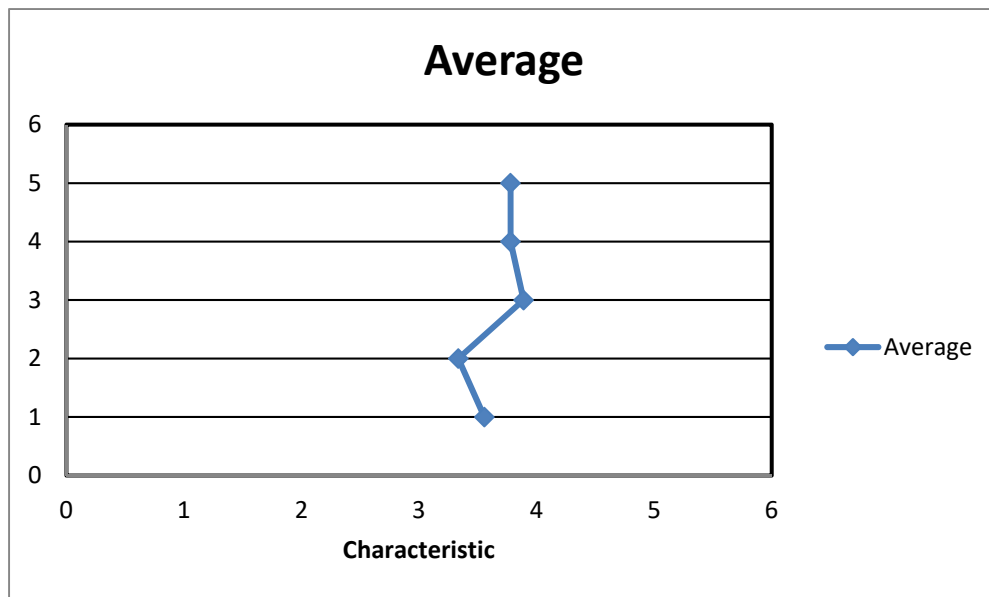

Figure 8: Shows the average RVI of each of the selected plant species

5.1.5. Plant Rotation

To optimize the productivity of each GreenWing a planting schedule was developed. Table (3) shows the proposed rotation for each crop. Using the designated schedule each wing was designed with the precise number of planting slots to reduce the waste of space. Using the growth time required by each crop, and estimated produce needed over the course of the year, a planting interval was created. Each GreenWing was sized to hold the necessary number of each crop.

Table 3: The planting schedule for each GreenWing

Plant	Designated Wing	Required Spacing (ft)	Time to maturity (Days)	Planting Interval (Days)
Snap Peas	1	0.5	60	2
Cucumber	1	1	70	2
Onion	1	0.5	120	4
Lettuce	2	0.5	60	1
Carrots	2	0.25	70	1
Spinach	3	0.33	60	3
Radish	3	0.5	35	2
Strawberry	4	3	-	-
Blackberry	4	4	-	-

6. Risk Analysis

6.1. Analysis and Mitigation of potential issues in Aeroponics

Analysis

Power Loss

In the event of power loss, there is a high chance that plants may not be able to survive for extended periods of time (greater than two hours). This is due to the pump and solenoid not functioning during loss of power.

Mitigation

Power Loss

Power Loss to the aeroponics system is mitigated by having the roots contained within a system with minimal air movement which reduces water loss due to evapotranspiration around the roots. Nevertheless, further measures need to be considered. One such solution would be to employ manual controls on the accumulators to allow for the system to be run for a limited amount of time without power. Furthermore, hand-held sprayers could be used to distribute water onto the roots.

AnalysisWater Loss

Due to the fact that water is a precious resource, and in limited availability in the greenhouse, evaporation of water from plant roots can contribute to concentrations of salts and nutrients in the nutrient solution reaching levels lethal to plants.

AnalysisHigh Pressure Lines

High pressure water lines will be more likely to expose any imperfections in the materials and assembly of the system. However, while any failures in the materials or assembly may cause the system to shut down in a limited capacity, none of the resulting leaks would result in highly dangerous situations for any astronauts present.

MitigationWater Loss

In order to reduce potentially toxic nutrient concentration levels, reverse osmosis or distillation processes will be used to desalinate water. Water will also be recaptured from the GreenWing atmosphere to help dilute these concentrations.

MitigationHigh Pressure Lines

To help mitigate issues with high pressure lines, regular inspection will be performed on the system. Any discovered issues would simply require the local system to be shut down temporarily while repairs are made.

AnalysisGermination and Crop Fatalities

There is a high chance that many plants will die during their life cycles. While this is expected for many plants that only produce one crop during their lifetimes, many other plants producing multiple crops are not susceptible to disease.

MitigationGermination and Crop Fatalities

To prevent any food shortages due to fatalities, an excess of plant seeds required for initial crops will be taken on the mission since seeds are very light and compact.

Additionally, in the case of pathogens causing the death of plants, sterilizing procedures will be developed to prevent the spread of pathogens to other plants. This will include the isolation and destruction of infected plants. All seeds and growing surfaces will be sterilized prior to deployment to prevent exposure to alien (coming from outside system) microbes, if they exist.

7. Analog Systems

Due to the complexity of this project, analog designs were developed to test concepts and functionality of individual systems of the deployable greenhouse. Many of these aspects were not able to be tested with a full-scale model due to time and budget constraints. In lieu of full-scale testing, numerous analog test systems were developed to establish that the core principles of the aeroponic design were functional.

7.1. Aeroponic Analog

In order to establish whether the germination and aeroponic systems would work properly, a 20-plant test system was designed and built. The design utilizes a timer to turn a high pressure pump on for one minute at ten minute intervals. Since this system does not use a bladder tank to store pressure, no other control system was required. To ensure the consistent quality of the fertilizer/nutrient solution in addition to ease of use, it was decided that SensiBloom Advanced Nutrients pH Perfect nutrient solution concentrate would be used. Furthermore, the nutrient solution was passed through a Rain Bird PRF-100-RBY irrigation filter to ensure the pump would not be damaged by dirt particles in the solution.

7.1.1. Design of Aeroponic Grow Bed

A major issue in designing grow bed was keeping humidity in the aeroponic system without using costly parts of intensive fabrication. Plastic wrap was used to seal the sides of the grow bed. The grow bed was also built with a sloped bottom, so that when the top was level, excess used nutrient solution would run to

the lower end and out the system. Figure 9 shows the constructed grow bed.



Figure 9: The constructed analog grow bed at the ARS Greenhouse.

7.1.2. Project Budget

Table 4 shows the budget for the grow bed analog. Many of the parts used to construct the analog came from recycled materials to reduce costs.

Table 4: Budget for Grow Bed Analog

Material	Cost (\$)
Scrap Plywood	0
1/4" Flex Hose	0
1/4" to 1/2" Adaptors	20
Custom Mister Tees	40
Mister Nozzles	30
30' of 1/2" PVC	5.28
Total	95.28

7.1.3. Germination Procedures and efforts

Two methods of germination were tested. The first method used damp coffee filters and the second method utilized the aeroponic disks for germination. The lettuce and carrot seeds grown in the coffee filter began to germinate within 3

days, and after 2 weeks were typically around 4 inches in length. The lettuce and carrot seeds placed in the aeroponic system showed little growth over the 2 weeks.

Table 5 shows the results of germination testing.

Table 5: Testing results for seed germination

Germination Method	Growth at 3 days	Growth at 2 weeks
Coffee Filter	90% of seeds germinated	100% of seeds germinated
In system	0% of seeds germinated	10% of seeds germinated

7.1.4. Analog Analysis

Germinated lettuce plants were purchased and inserted into the system. At the end of the test period of 30 days, it was observed that germination was not successful.

Germinated lettuce and carrot was then inserted into the neoprene disks to test plant growth in the aeroponics system. Little growth was observed in the system, even after healthy plants were transferred into the analog aeroponic system. This is likely due to the high variability in temperatures, lack of light, and system failures in the ARS greenhouse. On multiple occasions, the aeroponic control system had been shut off by non-team members, resulting in plant death. Also, the selected nutrient solutions did not supply the full range of necessary micronutrients. These factors in combination likely contributed to the lack of success in the aeroponic growth analog.

7.2. Functioning GreenWing Section

To provide a tangible model of how a GreenWing wall would look, an eight foot section of GreenWing was constructed, and all necessary aeroponic systems were installed in this section. Figure 10 shows this system. The analog showed that the aeroponic design would function in the designed wing and also served as a working

system for the nutrient solution instrumentation (7.3.1) to be tested for functionality. Four feet of the aeroponic system in the functioning GreenWing section is fully deployable. The other four feet is permanently in place to demonstrate the effectiveness of the aeroponics design. 55 gallon drums were used as tanks for the nutrient solution, pure water, and used nutrient solution. Separate 5 gallon buckets with lids were used to store the nutrient solution parts A and B. The nutrient solution instrumentation was integrated into the functioning analog in order to ensure functionality of the control systems. Both the GreenWing and the solution storage tanks were built onto rolling frames to allow the analogs to be moved whenever necessary.



Figure 10: Aeroponics systems housed in the GreenWing analog

7.3. Instrumentation Projects

7.3.1. Nutrient Solution System

As to create and distribute a nutrient solution to be distributed to plants in the

analog, an Instrumentation and Controls team designed and constructed a controls system prototype powered by an Arduino MEGA Microcontroller. The system itself incorporated the proposed design of the mission-ready system by reusing the collected runoff from the aeroponic system and remixing it to keep it within acceptable pH and electroconductivity ranges. The E.C., pH, and turbidity of the solution are all displayed within the GreenWing, helping display the functionality of the system in addition to presenting relevant information. Figure 11 shows the nutrient solution instrumentation and LCD display installed in the analog.

The mixing tank was monitored using a pH sensor (SEN-0161), and peristaltic pumps pumped either Part A or Part B of the nutrient solution used in germination analog to increase or decrease pH to a set acceptable range of 5.5 to 6.5.

Furthermore, to regulate the E.C. levels, an E.C. meter (SEN-12908) monitored the concentration to keep the concentrations between 2300 and 2500 $\mu\text{S}/\text{cm}$. Parts A and B were added to the mixing tank to increase or decrease the E.C. to the acceptable levels. Following the mixing tank, a high-pressure pump moves the fluid to a bladder tank that stores the liquid between 85 to 100 PSI, which is ready to be distributed to the aeroponic misters. The high-pressure pump is self-regulated to keep the pressure on the output at 100 PSI by turning itself on. This negates the need to physically monitor the pressure to turn on the pump in the analog. From the bladder tank, a solenoid controlled by the Arduino Microcontroller opens a valve on a pre-set time (e.g. 30 seconds on, two minutes off). The nutrient solution is then sent to the aeroponic nozzles and the runoff is

then collected in the larger pipe surrounding the nozzles. This runoff then drains into the used nutrient solution 55-gallon drum via gravity.

This system does not perfectly model the mission-ready system since fluid levels within the tanks are not monitored, thus reducing the analog system's ability to be completely self-regulated. Furthermore, the interface between the microcontroller and the pumps did not work effectively. It was believed that this was because the relay board wired to the Arduino Microcontroller did not allow for sufficient current to turn on any pumps or solenoids. Nonetheless, to effectively display our aeroponic system in the analog, we used the timer switch used in the aeroponic grow bed while the bladder tank was kept at pressure using the self-regulated high-pressure pump. Thus, instead of having the nutrient solution mixed just prior to being sent to the bladder tank for distribution, the analog system simply

corrects reused solution for an effective display of the mission-ready design.



Figure 11: Nutrient solution instrumentation housed in the analog

7.3.2. Environmental Monitoring System

In order to monitor the environmental conditions inside the GreenWing a sensor array was assembled to monitor conditions. This system can be seen in figure 12.

Each sensor was programmed to sound an alarm if any of the monitored conditions went outside of a set range. Two sensor arrays were placed in the analog at Richmond Hills, one inside the aeroponics tube and one outside the aeroponics tube. Each array consisted of a temperature sensor, humidity sensor, air pressure sensor, and a light sensor. Each array displayed the measured values on a 7" LCD touchscreen. Each array was also connected to a separate speaker.

The acceptable temperature range was 18 - 24°C. The acceptable humidity was 20

– 60%. The acceptable pressure was 9 – 10 psi, as determined by the deployability team. The light sensor was used to ensure that the lights were coming on when they were supposed to. The lighting sensor will be incorporated into the lighting controls group in the space-rated design. The environmental controls were successfully integrated into the full-scale analog at Richmond Hills. Sensors were calibrated using a Fluke® humidity and temperature sensor and found to be accurate. The alarm sounded whenever measured values exited the range of acceptable values.



Figure 12: The two LCD displays for the Environmental Sensors that were installed in the full-scale analog.

7.3.3. Lighting Controls

The initial design concept uses a graphical user interface that allows the user to select a crop that automatically changes the light settings to the appropriate lighting cycle for the selected crop. The interface also incorporates a series of error checking LED's indicate if the lights are working properly. During pre-analog testing it was found that the system

properly adjusted the light on-off cycle for each crop and plant row. The lighting controls were then installed into the full-scale analog as a standalone demonstration unit. Figure 13 shows the circuit system before the analog installation.

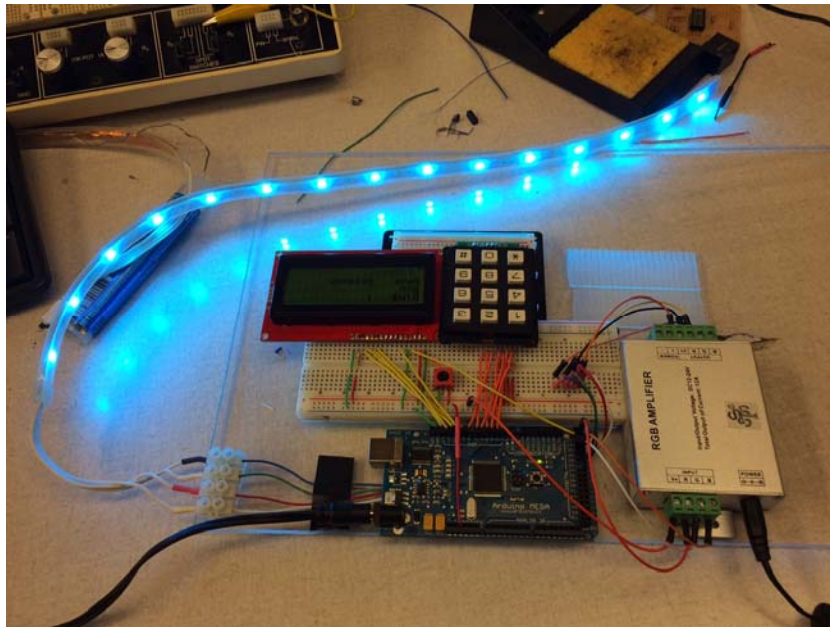

Figure 13: Desktop view of lighting system before analog installation

8. Environmental and Societal Impact

Most of the environmental impact will occur at or near the launch location due to exhaust and ignition fumes. Exhaust from rocket fuel will cause a temporary disruption in the air quality surrounding the launch site, while ignition will cause a temporary scorching of flora and fauna. After launch, jettisoned sections of the rocket will land in the ocean near the launch location. These sections will release small amounts of fuel and other contaminants into the water. Moreover, in the unfortunate event of an explosion, flying shrapnel may cause loss of life and property. If a small nuclear reactor (used as a power source for the greenhouse) is onboard during the explosion, radioactive fallout from the explosion may occur in the direction of the prevailing winds. Another potential effect is the introduction of microorganisms to the Martian surface. If this occurs, it is possible that some of the bacteria will grow under Martian conditions, and could grow into a formidable colony. The effects of this are unknown, and not heavily investigated.

Assuming a successful mission, researchers on the Martian surface will be able to investigate the possibility of permanent human habitation on Mars. Overpopulation of areas on Earth such as prisons or urban areas may be relieved by transferring people to Mars. In addition, the ability to send humans to Mars may benefit life on Earth by advancing current Earth technologies. This is due to the advancement of technologies needed to successfully complete a mission to Mars. Finally, travel to Mars may become a formidable aspect of the tourism industry, resulting in financial gain for those who can provide travel to Mars and sustainable habitation once on Mars.

9. Design Summary

The use of an aeroponic system for growth within the NASA X-Hab Greenhouse structure allows for increased yields with reduced water consumption over the mission duration compared to other systems. The creation of a resource viability index (RVI) allows mathematical design and modeling solutions to be applied in selection of plants and determination of planting schedule. The integration of all designs into the GreenWing in a deployable manner greatly increases the potential for this design to be implemented effectively.

10. Conclusions

A space-rated deployable greenhouse system was developed in conjunction with the Aerospace Engineering Design Team. The system includes the outer deployable structure as well as the aeroponic plant growing system. Furthermore, the Environmental Design Team constructed a test analog system that monitors lighting, environmental conditions, and nutrient solution distribution. These systems are fully operational and show that our space-rated design is a feasible system.

While the aeroponic test analog was successful at growing plants during the germination growth phase, the plants soon died following germination. Further research is needed to develop methods to sustain plant growth past germination using the aeroponics design that was developed by the Environmental Team.

Overall, our team was successful at working in a cross-functional environment not only to develop a deployable greenhouse, but also to advance the resources NASA can use for future missions.

11. Acknowledgements

First and foremost, The NASA X-Hab Environmental Team would like to thank Dr. Paul Weckler for helping guide us through our capstone project. Furthermore, we would also like to thank Dr. Carol Jones for her assistance in developing the RVI graphs. Likewise, we would like to thank Drs. Long and Penn for their expertise in various mechanical and water chemistry issues, respectively. Additionally, we would like to thank Drs. Dunford, Vogel, and Storm for their permission to use their greenhouse at the USDA-ARS hydraulics lab. We would also like to thank Drs. Jacob and O'Hara for assisting the X-Hab team throughout the entire process. Furthermore, we would like to thank our fellow students in aerospace engineering, architecture, and electrical engineering, for their help and camaraderie throughout entire project. We would like to especially thank Wayne Kiner and his crew for their fabrication assistance throughout the entire process. Furthermore, we would like to thank Austin Mitchell for designing our team's logo.

We would like to thank Dr. Wang and Meg Sheehan for their endless efforts in helping bring the controls side of the project together. On a related note, we would like to thank the students from BAE 3023 Instruments and Controls for their devotion to their projects and helping make the project a success. Furthermore, we would like to thank the BAE 1012 research groups for helping us research our project during the first semester.

Lastly, we would like to thank the National Space Grant Foundation for their financial support of this entire project. Furthermore, we would like to thanks NASA scientists

and engineers Tracy Gill, Morgan Simpson, Kelly Gattuso, Raymond Wheeler, and Gioia Massa for their technical assistance and advice throughout the year.

12. References Consulted

- Abdel-Fattah M. El-Sayed, N/A. Protein Nutrition of Farmed Tilapia: Searching for Unconventional Sources. Available at: <http://ag.arizona.edu/azaqua/ista/ista6/ista6web/pdf/364.pdf>. Accessed: 10/1/2014.
- Adey, Walter H., and Purgason, 1998. Method of Raising Fish by Using Algal Turf. US 5778823 A.
- Ako, H., Baker, A. 2009. Small-Scale Lettuce Production with Hydroponics or Aquaponics. College of Tropical Agriculture and Human Resources. SA-2.
- Amirkolaie, Abdolsamad Keramat. 2005. Dietary Carbohydrate and Fecal Waste in the Nile Tilapia (*Oreochromis niloticus* L.). PhD diss. Wageningen, Gelderland: Wageningen University, Animal Sciences.
- Barta, D. J., T. W. Tibbitts, R. J. Bula, and R. C. Morrow. 1992. Evaluation of light emitting diode characteristics for a space-based plant irradiation source. *Advanced Space Research*: Vol. 12 141-149.
- Bluem, V., Paris, F. 2003. Possible application of aquatic Bioregenerative life support modules for food production in a Martian base. *Advanced Space* 31:77-86.
- Brown, Christopher S., Andrew C. Schuerger, and John C. Sager. 1995. Growth and photomorphogenesis of pepper plants under red light-emitting diodes with supplemental blue or far-red lighting. *American Society of Horticultural Sciences*: 120(5):808-813.
- Bula, R. J., R. C. Morrow, T. W. Tibbitts, D. J. Barta, R.W. Ignatius, and T. S. Martin. 1991. Light-emitting diodes as radiation source for plants. *Horticulture Science*: 26(2):203-205.
- Cho, C., Bureau, D. 1998. Development of bioenergetics models and the Fish PrFEQ software to estimate production, feeding ration, and waste output in aquaculture. *Aquatic Living Resources*. 11: 199-210.
- Delong, Dennis P., Losordo, Tomas M., and Rakocy, James E., 2009. Tank Culture of Tilapia. SRAC Publication No. 282. Southern Region Aquaculture Center.
- Eding, E.H., Kamstra, A., Verreth, J.A.J., Huisman, E.A., and Klapwijk, A. 2002. Design and Operation of Nitrifying Trickling Filters in Recirculating Aquaculture: A Review. *Aquacultural Engineering* 34: 234-260.
- Folta, K. M., L. L. Koss, R. McMorrow, H. Ki, J. D. Kenitz, R. Wheeler, and J. C. Sager. Design and fabrication of adjustable red-green-blue LED light arrays for plant research. 2005. *BMC Plant Biology*: 5(17).
- Graber, Andreas, and Ranka Junge. 2007. Aquaponics Systems: Nutrient recycling from fish wastewater by vegetable production. *Desalination*: 246 (2009) 147-156.

- Greinder, A. D., and Timmons, M. B. 1998. Trickling Filters in an Intensive Recirculating Tilapia Production Facility. *Aquacultural Engineering*. 18:189-200.
- Ho, L. C., R. I. Grange, and A. J. Picken. 1987. An analysis of the accumulation of water and dry matter in a tomato fruit. *Plant, Cell and Environment*: 10:157-162.
- Konig, A. N. M. 1990. Long-term temperature integration of tomato. Grown and development under alternating temperature regimes. *Scientia Horticulturae*: 25:117-127.
- Kumar, Ramasamy Rajesh, and Jae Young Cho. 2014. Reuse of hydroponic waste solution. *Environmental Science Pollution*: 21:9569-9577.
- Kunjapur, A. M. and R. B. Eldridge. 2010. Photobioreactor Design for Commercial Biofuel Production from Microalgae. *Ind. Eng. Chem. Res.* 49: 3516-3526. <http://www.che.utexas.edu/eldridge-group/pdf/Aditya.pdf>. Accessed 17 Noveber 2014.
- Leatherbury, Megumi. Vegilab and aquaponics indoor growing system. 2014. Hawaii University International Conferences; Science, Technology, Engineering, Math, & Education. Honolulu, Hawaii.
- Lee, Choul-Gyun, and Palsson, Bernhard O., 1994. High-Density Algal Photobioreactors Using Light-Emitting Diodes. *Biotechnology and Bioengineering*. Vol. 44: 1161-1167.
- Lennard. W., Leonard, B. 2006. A comparison of three different hydroponic sub-systems (gravel bed, floating and nutrient film technique) in a Aquaponic test system. *Aquaculture International*. 14:539-550.
- Maathuis, Frans J.M. 2013. *Plant Mineral Nutrients Methods and Protocols*. York, UK: Springer Science.
- Mackowiak, C. L., G. W. Stutte, J. L. Garland, B. W. Finger, and L. M. Ruffe. 1997. Hydroponic potato production on nutrients derived from anaerobically-processed potato plant residues. *Advanced Space Research*: Vol. 20 No. 10:2017-2022.
- Mackowiak, C. L., R. M. Wheller, G. W. Stutte, N. C. Yorio, and J. C. Sager. 1997. Use of biologically reclaimed minerals for continuous hydroponic potato production in a CELSS. *Advanced Space Research*: Vol. 20 No. 10:1815-1820.
- Mackowiak, C.L., J.L. Garland, R.F. Strayter, B.W. Finger, and R. M. Wheller. 1996. Comparison of aerobically-treated and untreated crop residue as a source of recycled nutrients in a recirculating hydroponic system. *Advanced Space Research*.: Vol 18. 281-287.
- Massa, Gioia D., Hyeon-Hye Kim, Raymond M. Wheeler, and Cary A. Mitchell. 2008. Plant Productivity in Response to LED Lighting. *HortScience*: 43(7).
- Massa, Gioia D., Jeffrey C. Emmerich, Robert C. Morrow, C. Miuke Bourget, and Cary A. Mitchell. 2006. Plant-growth lighting for space life support: a review. *Graviational and Space Biology*: 19(2).

Mississippi State University. 2014. Tilapia Stocking Rate in Mississippi. Mississippi State University Extension Service. Available at: MSUcares.com/aquaculture/tilapia/stocking.htm. Accessed: 29 November 2014.

Mjoun, Kamal, Rosentrator, Kurt A., and Brown, Michael L. 2010. TILAPIA: Environmental Biology and Nutritional Requirements. South Dakota Cooperative Extension Service. FS963-02:1-7.

Muller, M.S., and Bauer, C.F., 1996. Oxygen Consumption of Tilapia and Preliminary Mass Flows through a Prototype Closed Aquaculture System. NASA-TM-111882: 1-17.

NASA. Advanced Space Transportation Program: Paving the Highway to Space. National Aeronautics and Space Administration. Available at: <http://www.nasa.gov/centers/marshall/news/background/facts/astp.html>. Accessed 17 November 2014.

Nelson, R. L., and Pade, J. S. 2007. Auaponic Equipment: The Clarifier. *Aquaponics Journal* Issue 47: 30-31.

Nir, I. 1982. GROWING PLANTS IN AEROPONICS GROWTH SYSTEM. *Acta Hort.* (ISHS) 126:435-448 http://www.actahort.org/books/126/126_49.htm. Accessed 17 November 2014.

Ono, Eiichi. 2001. Monitoring of nutrient solution for hydroponically grown sweetpotato (*ipomoea batatas*). PhD Dissertation. Tucson, AZ: The University of Arizona.

Peterson, L. A and A. R. Krueger. 1988. An Intermittent Aeroponics System. *Crop Science*. 28(4): 712-713. doi: 10.2135/cropsci1988.0011183X002800040033x.

Popma, Thomas J. and Lovshin, Leonard L. 1995. Worldwide Prospects for Commercial Production of Tilapia. International Center for Aquaculture and Aquatic Environments Department of Fisheries and Allied Aquaculture: 12-19

Rakocy, James E. 1989. Tank Culture of Tilapia. Southern Regional Aquacultural Center. Pub. No. 282(3).

Rosen, Carl J., and Roger Eliason. 2005. Nutrient management for commercial fruit & vegetable crops in Minnesota. University of Minnesota Department of Soil, Water, and Climate; University of Minnesota Extension Service; USA-Risk Management Agency.

Shalhevent, J., and B. Yaron. 1973. Effect of soil and water salinity on tomato growth. *Plant and Soil*: 39:285-292.

Shimokawa, Akihiro, Yuki Tonooka, and Misato Matsumoto. 2014. Effect of alternating red and blue light irradiation generated by light emitting diodes on the growth of leaf lettuce. *bioRxiv*. Available at: <http://dx.doi.org/10.1101/003103>. Accessed 1 October 2014.

Shnel, N., Barak, Y., Ezer, T., Dafni, Z., and Rijn, J.V. 2006. Design and Performance of a zero-discharge Tilapia Recirculating System. *Aquacultural Engineering* 26: 191-203.

Siddiqui, A., Al-Harbi, A. 1999. Nutrient budgets in tanks with different stocking densities of hybrid tilapia. *Aquaculture* 170: 245-252.

Sikawa, D. Yakupitiyage, A. 2010. The hydroponic production of lettuce by using hybrid catfish pond water: Potentials and constraints. *Agricultural Water Management*. Vol 97: 1317-1325.

Timmons, M. B., Summerfelt, S. T., Vinci, B. J. 1998. Review of Circular Tank Technology and Management. *Aquaculture Engineering* 18: 51-69.

Tokuyama, T., Mine, A., Kamiyama, K., Yabe, R., Satoh, K., Matsumoto, H., Takahashi, R., Itonaga, K. 2004. *Nitrosomonas communis* Strain YNSRA, an ammonia oxidizing bacterium, isolated from the reed rhizoplane in an aquaponics plant. *Bioscience and Bioengineering*. 98:309-312.

Wheeler, R. 2003. Carbon balance in Bioregenerative life support systems. *Advanced space* 31: 169-175.

Wheeler, Raymond M. 2010. Plants for human life support in space: from Myers to Mars. *Gravitational and Space Biology*: 23 (2).

Xiu-fen, Z. H. A. O. (2009). Study on Application of Algae Fertilizer on Vegetable Production [J]. *Journal of Anhui Agricultural Sciences*, 6, 115.

Yorio, Neil. C., Gregory D. Goins, Hollie R. Kagie, Raymond M. Wheeler, and John C. Sager. 2001. Improving spinach, radish, and lettuce growth under red light-emitting diodes (LEDs) with blue light supplementation. *HorticScience*: 36(2):380-383.

13. Appendices

13.1. Analog Expenditures

Table 6: Cost of Analog Projects

Carrot Seeds	1	4	4
Lettuce Seeds	1	4	4
Titan Controller	1	67.19	67.19
Threaded Tee	20	1.5	30
Atomizers	20	2	40
40 Bin	1	35	35
1/2" PVC End Cap	2	1.25	2.5
1/2" PVC Piping 10' Section	3	1.76	5.28
1/2" Elbows	2	0.29	0.58
1/2" Straight Tee	1	0.46	0.46
1/2" FNTP Male Thread PVC	2	2	4
Box Top 3/4" Plywood	1	0	0
Fertilizer Solution-	6	110.93	665.58
Lumigrow Grow Light	1	0	0
Neoprene Inserts 25 ct	1	15	15
Plywood Sealer- 1 gallon	1	16	16
Net Pot Baskets 100 ct	1	13.33	13.33
In Line filters (~130um)	10	2	20
PVC Cement and Primer 8 fl oz	1	8.72	8.72
1/2" PVC End Cap	2	1.25	2.5
1/2" PVC Piping 10' Section	3	1.76	5.28
1/2" Elbows	2	0.29	0.58
1/2" Straight Tee	1	0.46	0.46
Plywood Sealer- 1 gallon	1	20	20
PVC Cement and Primer 8 fl oz	2	8.72	17.44
100 PSI Pump	1	339.96	339.96
8" PVC Pipe	1	0	0
8" End Cap	1	105.68	105.68
Total Spent			1423.54

13.2. Notes from PDR

Tracy Gill-

- HDU
 - No weight optimization by NASA
 - All weights are from analog
 - Need to optimize for flight design

Morgan Simpson-

- What does greenwing analog look like?
 - Answer
 - Check to see if it inflates properly
 - Pack properly
 - Test aeroponics system
 - Automate as many things as possible

Ray Wheeler

- Liked the modular concept- ability to grow in the future
- LEDs- prudent
- Aeroponics vs. recirculating hydroponics
 - Would aeroponics actually use less water?
 - Water use and nutrient use are probably close to the same for each
- Failure and risk analysis
 - Pump failures
 - Need to respond quickly for plants to survive
 - How would we prevent wilting
 - Cool temperature
 - Turn lights off
 - Could use ponded water (if roots reach water)

Gioia Massa

- Likes design- potential
- Is everything an opaque structure?
- Thermal qualities of chosen materials?
 - Answer
 - Kevlar and Kapton
 - Gases
 - Replenish CO₂
 - O₂ level management
 - Answer = airlock
 - Central hub has control
 - Each greenwing can have different atmospheric conditions
 - Gases can be routed from wing to wing
 - Consider compressed gases
 - Feed back in when needed
 - Younger plants will not be producing as much O₂
 - Balance by rotating plants

- Stagnation of air occurs in large commercial greenhouses
 - Consider fans to move air
 - Shape and organization of lights
 - Pack them in?
 - Strip lights
 - Instead of changing lighting configuration, could change plant location

Headhouse Section

- Use for “dirty” operations
- Layout and materials handling

Mass

- Look at ISS masses for a flight mass baseline
 - MPLM
 - Look at modules with similar number of parts
 - Scale up ISS modules since they are not 5m in diameter

Gioia Massa

- Humidity control from plants
- Condensing surfaces
 - Where would we put them
 - What type of surfaces
- Could use Mars to help with thermal gradient
- Could use condensation as potable water

Charlie

- Need to protect structure
 - Radiation
 - Particles from arriving vehicles
 - Kevlar as skin protection- how does this work with radiation
 - Need to do more research

Additive Manufacturing

- 3D printed regolith for printing
- Currently printing test coupons on ISS with 3D printer
- Even if tech is only emerging, do not discount its use in the future

Compile a list of assumptions

- Answer
 - We are not considering unlimited resources
 - Assuming landing vehicle

For CDR

- Provide organizational/structural diagram
- Show presenters picture when they are talking

Dr. O'Hara

- Consider having inflatable greenwing structure hoops- easy to store
- Telescopic greenwing floor
- Can we fit all greenhouse systems in one flight

Dr. Wang

- What are we going to do with diseased plants?
 - Can sterilize system
 - Moisture will produce mold
 - Look at cleaning process/solution
 - No biofilms

13.3. Notes from SDR

Team's Question	NASA's Answer
Target crew size?	<ul style="list-style-type: none"> • Up to team • 4 to 6
Mission duration?	<ul style="list-style-type: none"> • Not fully defined by NASA • 6 months, 1 year, 500 days • Up to team (within reasonability)
Should crops grown be supplementary to diet or comprise the whole diet?	<ul style="list-style-type: none"> • Evolutionary approach: start as supplemental and move to whole diet • Concentrate on near time
Any particular crops you DO or DO NOT want?	<ul style="list-style-type: none"> • Concentrate on near time • Salad crops • Minimal processing crops (potatoes) • Wheat, soybeans, etc. need additional infrastructure • Eaten fresh and minimal processing, cooking capabilities • Literature can/will be provided
Dimension restrictions?	<ul style="list-style-type: none"> •
Bring Earth soil or use Martian?	<ul style="list-style-type: none"> • Consider hydroponics (need to bring water regardless of growth media) • Soil testing may be out of schedule range • Dr. Jacob article- http://io9.com/new-evidence-that-we-could-grow-vegetables-on-mars-and-1636418166
Any preferable location?	<ul style="list-style-type: none"> • Low latitudes get the best sun • Radiation function of altitude- lower=better
Types of primary/secondary energy sources for greenhouse?	<ul style="list-style-type: none"> •
Potential complications with attempting to harvest nutrients/air from Mars?	<ul style="list-style-type: none"> • Literature can/will be provided
Potential for aquaculture?	<ul style="list-style-type: none"> • Interesting idea worth further investigation

13.4. **Liu et al, 2008**

This paper proposed a conceptual configuration for bioregenerative life support system (BLSS) on the lunar surface. It was proposed that crops be grown in a matrix of dry

plant waste as well as added water. Calculations were also performed to estimate the total production of the system and the calories available to astronauts due to crop production.

Bluem and Paris, 2003

This paper investigated the establishment of a bioregenerative life support system (BLSS) on a small scale during space shuttle missions STS-89 and STS-90. From their findings it was concluded that the establishment of a closed loop system using water plants and fish was feasible in a microgravity environment. The reproductive capacity of the fish was not inhibited in any way.

Aeroponic System and Method

US 20140137471 A1

Accessed: Google Patents 11/29/2014

Abstract:

Exemplary embodiments are directed to an improvement of an aeroponic system including a growth chamber and cloth support elements. The improvement generally includes a cloth supported by the cloth support elements. The cloth advantageously satisfies a wicking height parameter and an absorbance parameter so as to deliver advantageous aeroponic performance. The wicking height parameter is a measurement of an ability of the cloth or fabric to absorb moisture. The absorbance parameter is a measurement of moisture the cloth or fabric retains. Exemplary methods of aeroponic farming in an aeroponic system are also provided.

Relevance:

This patent describes a way of setting up aeroponics system and growing plants. Cloth is used as an absorbance media for plant nutrients as well as prohibits pooling of nutrient solutions, preventing seed drowning. The seed is placed on the cloth and then germinates, allowing the roots to break through the cloth. Cloth may be considered or at least acknowledged during the design of our aeroponic system.

Automated aeroponic plant growing system

WO 2014102553 A1

Accessed: Google Patents 11/29/2014

Abstract:

A fully automated aeroponic plant growing system, is monitored and controlled by only a central digital automatic operation unit for all the individual parts and on line monitoring capability. It has the ability to simultaneously support multiple aeroponic crops or growing treatments with different nutritional requirements, or only one aeroponic crop. Simultaneously prepares, sterilizes and controls all individual and different nutrient solutions needed to feed plants, which are sprayed onto the roots through the recirculation support system. It has the ability to control and adjust at any given value the root zone atmosphere temperature into growing chambers or vessels, by monitoring and controlling the temperature of nutrient solution sprayed to the roots, offering ideal root growth conditions to grow plants. This is made entirely of suitable insulating material, Capable to support parallel or not, all known hydroponic and Aeroponic cultivation systems and suitable for any open or closed environment.

Relevance:

This patent employs a digital automation operation unit to control all aspects of the aeroponic growing system. The monitoring and automated aspects that the patent describes (nutrient monitoring, lighting, and watering frequencies) are areas that the Environmental Team plans to incorporate into the final design.

Modular Automated Aeroponic Growth System

US 20140144078 A1

Accessed: Google Patents 11/29/2014

Abstract:

An aeroponic growth system comprising a plurality of modular aeroponic units each including at least one spray nozzle directed into a root zone; a lighting system associated with the plurality of the modular units and configured for emitting light in a vegetative zone; a pressurized reservoir configured for housing a nutrient containing fluid; and a nutrient feeding system configured for fluidly and selectively connecting each of the modular units to the pressurized reservoir in parallel, wherein the nutrient feeding system includes a pressure stop valve associated with each of the modular units. When one of the modular units are disconnected to the associated pressure stop valve, the pressure stop valve is configured for preventing the fluid from flowing from the pressurized reservoir through the pressure stop valve, and the other modular units connected to the nutrient feeding system remain fluidly connected to the pressure reservoir.

Relevance:

The modular, lighting, nozzle watering, and pressure vessel aspects of the design described in this patent are all relevant to the final design of our aeroponics system. The Environmental team will be considering ways to incorporate all of these aspects to the final design.

Aeroponic plant growing system

US 7823328 B2

Accessed: Google Patents 11/29/2014

Abstract:

An aeroponic plant growing system includes a water reservoir and growing chambers for growing plants in an aeroponic environment. A pump, a water distribution manifold, and water lines are used to provide water and nutrients from the water reservoir to sprayers in the growing chambers where the water and nutrients are sprayed on the roots of plants growing therein. The water distribution manifold and water lines preferably are provided as closed loop systems, such that water is provided to all sprayers despite a blockage in the manifold or a water line. Non-absorbed water and nutrients are returned to the water reservoir from the growing chambers on water return lines via a filter that includes multiple types of filter media, including filter media that support the colonization of organisms that support plant growth.

Relevance:

This patent describes a closed loop system to provide water to the sprayers and recycle the water back to the reservoir. The returned water is filtered via a filter media that can include bacteria or fungi which adds nutrients to the plants through nitrogen fixation. A

closed loop system is being designed by the Environmental Team for the aeroponics system. Organisms in the filter media will be considered or acknowledged as a possible although unlikely design aspect.

13.5. Comments from NASA:

- Look for ways to scale back project to stay on schedule and budget
 - Composting and soil testing may take too long
- NASA estimates per person
 - 40-50 m²
 - 2,500 Cal/day
- Plants require 1/3 to 1/4 atm
 - O₂ partial pressure = 10-15 kPa
- Okstate Mockup
 - Full/final not a totally closed system for safety reasons
 - Smaller closed system test
- Possible buried structure?
 - Penny Boston
 - Lava tubes
 - Protects against environment (dust, wind, etc.)
 - <http://www.space.com/18546-mars-caves-sample-return-mission.html>
 - <http://www.spacedaily.com/news/mars-life-04w.html>
- Light
 - Not UV
 - Usually use red/blue LEDs
 - Fiber optic?
- Must recycle ET
- Water from Mars

Schedule/Future Presentation Comments:

- Flexible on dates
- Do not have to review topics from previous presentations
- Final report: Can be in whatever form/format Okstate requires
- Possible communication with other X-Hab teams?
- Give monthly/bi-weekly updates to NASA contacts
- Cc Kelsey, Jessica, Dr. Jacob if communicating with NASA contacts

Future Questions:

1. Food storage?
2. Dimension restrictions? SLS?
 - a. Dimensions of module?
 - b. Mass?
 - c. Volume?
3. Types of primary/secondary energy sources for greenhouse?
4. Water in soil?
5. Major obstacles/questions encountered by contacts in their research?
 - a. What do they specifically want us to consider/think about? What is important to them in terms of design?

13.6. Lab Code for Environmental Group

```

#include <SPI.h>
#include <LiquidCrystal.h>

LiquidCrystal lcd(12, 11, 5, 4, 3, 2);

const int OSU =36;
const int sensorPin=A1;
int HIH4030_Pin = A0; //analog pin 0
#define NWS_BARO 29.92

// Pin definitions
#define MPL115A1_ENABLE_PIN 49
#define MPL115A1_SELECT_PIN 53

// Masks for MPL115A1 SPI i/o
#define MPL115A1_READ_MASK 0x80
#define MPL115A1_WRITE_MASK 0x7F

// MPL115A1 register address map
#define PRESH 0x00 // 80
#define PRESL 0x02 // 82
#define TEMPH 0x04 // 84
#define TEMPL 0x06 // 86

#define A0MSB 0x08 // 88
#define A0LSB 0x0A // 8A
#define B1MSB 0x0C // 8C
#define B1LSB 0x0E // 8E
#define B2MSB 0x10 // 90
#define B2LSB 0x12 // 92
#define C12MSB 0x14 // 94
#define C12LSB 0x16 // 96
#define C11MSB 0x18 // 98
#define C11LSB 0x1A // 9A
#define C22MSB 0x1C // 9C
#define C22LSB 0x1E // 9E

// Unit conversion macros
#define FT_TO_M(x) ((long)((x)*(0.3048)))
#define KPA_TO_INHG(x) ((x)*(0.295333727))
#define KPA_TO_MMHG(x) ((x)*(7.50061683))
#define KPA_TO_PSI(x) ((x)*(0.145037738))
#define KPA_TO_KGCM2(x) ((x)*(0.0102))
#define INHG_TO_PSI(x) ((x)*(0.49109778))
#define DEGC_TO_DEGF(x) ((x)*(9.0/5.0)+32)

```

```
void setup()
{

  pinMode(OSU, OUTPUT);
  pinMode(sensorPin,INPUT);
  Serial.begin(9600);
  SPI.begin();

  pinMode(MPL115A1_SELECT_PIN, OUTPUT);
  pinMode(MPL115A1_ENABLE_PIN, OUTPUT);

  digitalWrite(MPL115A1_ENABLE_PIN, LOW);
  digitalWrite(MPL115A1_SELECT_PIN, HIGH);

  Serial.println("Set-Up Complete");

  // set up the LCD's number of columns and rows:
  lcd.begin(16, 4);
  // Print a message to the LCD.
  lcd.print("psia ");
  lcd.setCursor(0,1);
  lcd.print("kPa ");
  lcd.setCursor(0,2);
  lcd.print("humid ");
  lcd.setCursor(0,3);
  lcd.print("temp ");
  lcd.setCursor(12,0);
  lcd.print("LTI");

}
void loop()
{
  int rate=analogRead(sensorPin);
  float temperature = 25;
  float relativeHumidity = getHumidity(temperature);
  float pressure_pKa = 0;
  float temperature_c= 0;
  long altitude_ft = 0;

  delay(100); //just here to slow it down so you can read itfloat getHumidity(float
degreesCelsius)

  digitalWrite(MPL115A1_ENABLE_PIN, HIGH);
```

```
delay(20);

pressure_pKa = calculatePressurekPa();
temperature_c = calculateTemperatureC();

digitalWrite(MPL115A1_ENABLE_PIN, LOW);

Serial.print(KPA_TO_PSIA(pressure_pKa), 2);
Serial.print(" psia | ");
Serial.print(pressure_pKa, 1);
Serial.print(" kPa ");
Serial.print("Relative Humidity = ");
Serial.print(relativeHumidity);
Serial.print(" Temperature = ");
Serial.print(temperature_c, 1);
Serial.print(" C | ");
Serial.print(DEGC_TO_DEGF(temperature_c), 1);
Serial.print(" F ");
Serial.print(" Light Intensity is ");
Serial.println(rate);

//Temperature parameter

if (temperature_c < 18 || temperature_c > 24){
  for (int i = 0 ; i < 4; i++){
    tone(OSU,3500);
    delay(200);
    continue;
  }
  for (int i = 0 ; i < 4; i++){
    noTone (OSU);
    delay(200);
    continue;
  }
}

// Pressure parameter
if (pressure_pKa < 95 || pressure_pKa > 100){
  for (int i = 0 ; i < 4; i++){
    tone(OSU,3500);
    delay(200);
    continue;
  }
  for (int i = 0 ; i < 4; i++){
    noTone (OSU);
```

```

        delay(200);
        continue;
    }
}
//Humidity parameter
if (relativeHumidity < 20 || relativeHumidity > 80){
    for (int i = 0 ; i < 4; i++){
        tone(OSU,3500);
        delay(200);
        continue;
    }
for (int i = 0 ; i < 4; i++){
    noTone (OSU);
    delay(200);
    continue;
}
}

// set the cursor to column 0, line 1
// (note: line 1 is the second row, since counting begins with 0):
lcd.setCursor(6,0);
lcd.print(KPA_TO_PSIA(pressure_pKa), 2);
lcd.setCursor(6,1);
lcd.print(pressure_pKa, 1);
lcd.setCursor(6,2);
lcd.print(relativeHumidity);
lcd.setCursor(6,3);
lcd.print(temperature_c, 1);
lcd.setCursor(6,4);
lcd.print(DEGC_TO_DEGF(temperature_c), 1);
lcd.setCursor(16,0);
lcd.print(rate);
// print the number of seconds since reset:
}

float getHumidity(float degreesCelsius)
{
    //caculate relative humidity
    float supplyVolt = 5.0;

    // read the value from the sensor:
    int HIH4030_Value = analogRead(HIH4030_Pin);
    float voltage = (HIH4030_Value/1023. * supplyVolt); // convert to voltage value

```

```

// convert the voltage to a relative humidity
// - the equation is derived from the HIH-4030/31 datasheet
// - it is not calibrated to your individual sensor
// Table 2 of the sheet shows the may deviate from this line
float sensorRH = 161.0 * voltage / supplyVolt - 25.8;
float trueRH = sensorRH / (1.0546 - 0.0026 * degreesCelsius); //temperature
adjustment

```

```

return trueRH;
}

```

```

float calculateTemperatureC() {

```

```

    unsigned int uiTadc;
    unsigned char uiTH, uiTL;

```

```

    unsigned int temperature_counts = 0;

```

```

    writeRegister(0x22, 0x00); // Start temperature conversion
    delay(2); // Max wait time is 0.7ms, typ 0.6ms

```

```

    // Read pressure
    uiTH = readRegister(TEMPH);
    uiTL = readRegister(TEMPL);

```

```

    uiTadc = (unsigned int) uiTH << 8;
    uiTadc += (unsigned int) uiTL & 0x00FF;

```

```

    // Temperature is a 10bit value
    uiTadc = uiTadc >> 6;

```

```

    // -5.35 counts per °C, 472 counts is 25°C
    return 25 + (uiTadc - 472) / -5.35;
}

```

```

float calculatePressurekPa() {

```

```

    // See Freescale document AN3785 for detailed explanation
    // of this implementation.

```

```

    signed char sia0MSB, sia0LSB;
    signed char sib1MSB, sib1LSB;
    signed char sib2MSB, sib2LSB;
    signed char sic12MSB, sic12LSB;
    signed char sic11MSB, sic11LSB;
    signed char sic22MSB, sic22LSB;

```

```

signed int sia0, sib1, sib2, sic12, sic11, sic22, siPcomp;
float decPcomp;
signed long lt1, lt2, lt3, si_c11x1, si_a11, si_c12x2;
signed long si_a1, si_c22x2, si_a2, si_a1x1, si_y1, si_a2x2;
unsigned int uiPadc, uiTadc;
unsigned char uiPH, uiPL, uiTH, uiTL;

writeRegister(0x24, 0x00); // Start Both Conversions
//writeRegister(0x20, 0x00); // Start Pressure Conversion
writeRegister(0x22, 0x00); // Start temperature conversion
delay(2); // Max wait time is 1ms, typ 0.8ms

// Read pressure
uiPH = readRegister(PRESH);
uiPL = readRegister(PRESL);
uiTH = readRegister(TEMPH);
uiTL = readRegister(TEMPL);

uiPadc = (unsigned int) uiPH << 8;
uiPadc += (unsigned int) uiPL & 0x00FF;
uiTadc = (unsigned int) uiTH << 8;
uiTadc += (unsigned int) uiTL & 0x00FF;

// Placing Coefficients into 16-bit Variables
// a0
sia0MSB = readRegister(A0MSB);
sia0LSB = readRegister(A0LSB);
sia0 = (signed int) sia0MSB << 8;
sia0 += (signed int) sia0LSB & 0x00FF;

// b1
sib1MSB = readRegister(B1MSB);
sib1LSB = readRegister(B1LSB);
sib1 = (signed int) sib1MSB << 8;
sib1 += (signed int) sib1LSB & 0x00FF;

// b2
sib2MSB = readRegister(B2MSB);
sib2LSB = readRegister(B2LSB);
sib2 = (signed int) sib2MSB << 8;
sib2 += (signed int) sib2LSB & 0x00FF;

// c12
sic12MSB = readRegister(C12MSB);
sic12LSB = readRegister(C12LSB);
sic12 = (signed int) sic12MSB << 8;

```



```

sic12 += (signed int) sic12LSB & 0x00FF;

// c11
sic11MSB = readRegister(C11MSB);
sic11LSB = readRegister(C11LSB);
sic11 = (signed int) sic11MSB << 8;
sic11 += (signed int) sic11LSB & 0x00FF;

// c22
sic22MSB = readRegister(C22MSB);
sic22LSB = readRegister(C22LSB);
sic22 = (signed int) sic22MSB << 8;
sic22 += (signed int) sic22LSB & 0x00FF;

// Coefficient 9 equation compensation
uiPadc = uiPadc >> 6;
uiTadc = uiTadc >> 6;

// Step 1 c11x1 = c11 * Padc
lt1 = (signed long) sic11;
lt2 = (signed long) uiPadc;
lt3 = lt1*lt2;
si_c11x1 = (signed long) lt3;

// Step 2 a11 = b1 + c11x1
lt1 = ((signed long)sib1)<<14;
lt2 = (signed long) si_c11x1;
lt3 = lt1 + lt2;
si_a11 = (signed long)(lt3>>14);

// Step 3 c12x2 = c12 * Tadc
lt1 = (signed long) sic12;
lt2 = (signed long) uiTadc;
lt3 = lt1*lt2;
si_c12x2 = (signed long)lt3;

// Step 4 a1 = a11 + c12x2
lt1 = ((signed long)si_a11<<11);
lt2 = (signed long)si_c12x2;
lt3 = lt1 + lt2;
si_a1 = (signed long) lt3>>11;

// Step 5 c22x2 = c22*Tadc
lt1 = (signed long)sic22;
lt2 = (signed long)uiTadc;
lt3 = lt1 * lt2;

```

```

    si_c22x2 = (signed long)(lt3);

    // Step 6 a2 = b2 + c22x2
    lt1 = ((signed long)sib2<<15);
    lt2 = ((signed long)si_c22x2>>1);
    lt3 = lt1+lt2;
    si_a2 = ((signed long)lt3>>16);

    // Step 7 a1x1 = a1 * Padc
    lt1 = (signed long)si_a1;
    lt2 = (signed long)uiPadc;
    lt3 = lt1*lt2;
    si_a1x1 = (signed long)(lt3);

    // Step 8 y1 = a0 + a1x1
    lt1 = ((signed long)sia0<<10);
    lt2 = (signed long)si_a1x1;
    lt3 = lt1+lt2;
    si_y1 = ((signed long)lt3>>10);

    // Step 9 a2x2 = a2 * Tadc
    lt1 = (signed long)si_a2;
    lt2 = (signed long)uiTadc;
    lt3 = lt1*lt2;
    si_a2x2 = (signed long)(lt3);

    // Step 10 pComp = y1 + a2x2
    lt1 = ((signed long)si_y1<<10);
    lt2 = (signed long)si_a2x2;
    lt3 = lt1+lt2;

    // Fixed point result with rounding
    //siPcomp = ((signed int)lt3>>13);
    siPcomp = lt3/8192;

    // decPcomp is defined as a floating point number
    // Conversion to decimal value from 1023 ADC count value
    // ADC counts are 0 to 1023, pressure is 50 to 115kPa respectively
    decPcomp = ((65.0/1023.0)*siPcomp)+50;

    return decPcomp;
}

unsigned int readRegister(byte thisRegister) {

```

```

byte result = 0;

// select the MPL115A1
digitalWrite(MPL115A1_SELECT_PIN, LOW);

// send the request
SPI.transfer(thisRegister | MPL115A1_READ_MASK);
result = SPI.transfer(0x00);

// deselect the MPL115A1
digitalWrite(MPL115A1_SELECT_PIN, HIGH);

return result;
}

void writeRegister(byte thisRegister, byte thisValue) {

// select the MPL115A1
digitalWrite(MPL115A1_SELECT_PIN, LOW);

// send the request
SPI.transfer(thisRegister & MPL115A1_WRITE_MASK);
SPI.transfer(thisValue);

// deselect the MPL115A1
digitalWrite(MPL115A1_SELECT_PIN, HIGH);
}

```

Lab Code for Nutrient Solution Team

```

#include <SD.h>
#include <SPI.h>
const int chipSelect = 4;
//Code to run Nutrient Supply System for XHab - NASA Senior Design Competition
//Uses electroconductivity sensor, pH sensor, thermistor, and set of 8 relays
//LCD displays parameters read by sensors
//Relays provide and shut off power to pumps
//by Taylor Conley

#include <SoftwareSerial.h> //includes software package for EC sensor
#define rx 4 //Puts EC rx pin at Arduino digital pin 4
#define tx 5 //Puts EC tx pin at Arduino digital pin 5
#define SensorPin A0 //pH meter Analog output to Arduino Analog Input 0
#define relay1 6 //declares relay 1 at Arduino pin 6
#define relay2 7 //declares relay 2 at Arduino pin 7
#define relay3 8 //declares relay 3 at Arduino pin 8
#define relay4 9 //declares relay 4 at Arduino pin 9

```

```

#define relay5 5
#define relay6 10

unsigned long int avgValue; //Store the average value of the sensor feedback
float b;
int buf[10],temp;

SoftwareSerial EleCon(rx, tx);
char EC_data[48]; //designates memory space - 20 byte character array for
sensor
char computerdata[20]; //designates memory space - 20 byte character array for
computer data
byte received_from_computer=0; //we need to know how many characters have been
received from the computer
byte received_from_sensor=0; //we need to know how many characters have been
received from the sensor
byte string_received=0; //identifies when a string has been received from the
sensor

float EC_float=0; //floating data to measure electroconductivity with
float TDS_float; //floating data to measure the TDS of the solution
char *EC; //points to float value identified earlier
char *TDS; //points to TDS float value identified earlier

const int SensePin = A2; //thermistor input at pin 0

#include <SoftwareSerial.h> //include library for LCD screen
SoftwareSerial mySerial(3,2); //rx/tx for
int pH, ec, tds, tem;
char pHstring[10], ecstring[10], tdsstring[10], temstring[10];

void setup()
{
Serial.begin(9600);
mySerial.begin(9600);
EleCon.begin(9600);
while (!Serial){
;
Serial.print("Initializing SD card...");
pinMode(chipSelect, OUTPUT);
if(!SD.begin(chipSelect))
Serial.println("Card failed, or not present");
return;
Serial.println("card initialized.");
}
}

```

```

//sets the pins the relays are in as an output signal

pinMode(relay1, OUTPUT);
pinMode(relay2, OUTPUT);
pinMode(relay3, OUTPUT);
pinMode(relay4, OUTPUT);
pinMode(relay5, OUTPUT);
}
void serialEvent(){
  received_from_computer=Serial.readBytesUntil(13,computerdata,20);
  computerdata[received_from_computer]=0;
  EleCon.print(computerdata);
  EleCon.print('\r');
}
void loop() {
  mySerial.write(254);          //Starts writing on LCD
  mySerial.write(0x01);        //clears LCD screen

  if(EleCon.available() > 0)   //If there is electroconductivity to be read
    received_from_sensor=EleCon.readBytesUntil(13,EC_data,48); //read the data
for the parameters set
  EC_data[received_from_sensor]=0; //declare the data as a
variable dependent upon the data received from the sensor

  if((EC_data[0] >= 48) && (EC_data[0] <=57)){ //If the data fits within
the array of 48 to 57
    pars_data(); //call the pars_data method
  }
  else
  mySerial.write(254);
  mySerial.write(128);
  mySerial.print("EC:"); //write "EC:" on LCD
  mySerial.print(EC_float); //write float vairable on the LCD
  {ECrelayswitch(); //call ECrelayswitch method
  }
}

//pH sensor code
for(int i=0;i<10;i++) //Get 10 sample value from the sensor for smooth the value
{
  buf[i]=analogRead(SensorPin); //read the sensor from analog pin
  delay(10); //delay for 10 ms
}
for(int i=0;i<9;i++) //sort the analog from small to large
{
  for(int j=i+1;j<10;j++)

```

```

    {
      if(buf[i]>buf[j])
      {
        temp=buf[i];
        buf[i]=buf[j];
        buf[j]=temp;
      }
    }
  }
  avgValue=0;
  for(int i=2;i<8;i++)          //take the average value of 6 center sample
    avgValue+=buf[i];
  float pHValue=(float)avgValue*5.0/1024/6; //convert the analog into millivolt
  pHValue=3.5*pHValue;          //convert the millivolt into pH value
  mySerial.write(254);          //Start writing on LCD
  mySerial.write(192);          //Set cursor on first space
  mySerial.print("pH:");        //write "pH" at place of cursor
  mySerial.print(pHValue,2);    //write sensed pH value up to two
  delay(3000);                  //keep it on the screen for 3 seconds
  digitalWrite(13, HIGH);
  delay(1000);
  digitalWrite(13, LOW);

  mySerial.write(254);          //Start code for LCD
  mySerial.write(0x01);        //clear LCD screen

//Thermistor Code
int V = analogRead(SensePin); //Sets up voltage reading as a float variable
float x = (5.0 * V)/1023.0; //Corrects voltage value
float R1 = 5100*(1023.0/int(V)-1.0); //Sets up R1 as floating variable and
calculates thermistor resistance as a function of the voltage
float T1 = 1.0/(0.002271-
0.0001108*log(R1)+0.000003104*(log(R1)*log(R1)*log(R1))); //Sets up temperature
as a floating variable and inputs the equation that will calculate the changing
temperature based off of the thermistor readings
T1 = T1 - 273.15; //Changes unit of K to *C

//Relay Codes
//Thermistor Reading displayed on LCD
mySerial.write(254); //initiate LCD writing
mySerial.write(128); //Move cursor to the beginning of the line
mySerial.print("Temp:"); //print calculated temperature value
mySerial.print(T1); //prints temperature to LCD display
delay(1000); //delay 2 seconds

//pH increasing solution relay

```

```
if (phValue < 5.5){
  digitalWrite(relay2, LOW); //NUTRIENT A = 2 closes relay circuit - provides
power to pump
  tone(4,3000); //hold tone on pin 4 at frequency of 3000 Hz
  delay(5000); //keep it on for 5 seconds
  digitalWrite(relay2, HIGH); //opens relay circuit - cuts off power to pump
  noTone(4); //No tone on pin 4
}
else {
  digitalWrite(relay2, HIGH); //keep relay off
}
//pH reducing solution relay
if (phValue > 6.5){
  digitalWrite(relay3, LOW); //NUTRIENT B = 3 closes relay circuit - provides
power to
  tone(4,3000); //hold tone on pin 4 at frequency of 3000Hz
  delay(5000); //keep it on for 5 seconds
  digitalWrite(relay3, HIGH); //opens relay circuit - cuts off power to pump
  noTone(4); //no tone on speaker at pin 4
}
else {
  digitalWrite(relay3, HIGH); //keep relay off if parameters aren't met
}

//Solenoid relay
digitalWrite(relay4, LOW); //SOLENOID VALVE (KEPT "ON" ON
APPARATUS)
  delay(2000); //keep power connected for 5 seconds
  digitalWrite(relay4, HIGH); //open relay circuit - cuts off power to solenoid
  delay(2000);

//12V relay
digitalWrite(relay5, LOW); //turn on relay for 12V power supply pump
  delay(5000); //delay for 5 seconds
  digitalWrite(relay5, HIGH); //turn off relay for 12V power supply pump
  delay(1200);

//Sump Pump Relay
digitalWrite(relay6, LOW); //turn on sump pump relay
  delay(5000); //keep on for 5 seconds
  digitalWrite(relay6, HIGH); //turn off sump pump relay
  delay(1200); //delay for 1.2 seconds before going on to next command

//SD shield code
{
```

```

// make a string for assembling the data to log:
String dataString = "";
// read three sensors and append to the string:
for (int analogPin = 0; analogPin < 3; analogPin++) {
  int sensor = analogRead(analogPin);
  dataString += String(sensor);
  if (analogPin < 2) {
    dataString += ",";
  }
}
// open the file. note that only one file can be open at a time,
// so you have to close this one before opening another.
File dataFile = SD.open("datalog.txt", FILE_WRITE);
// if the file is available, write to it:
if (dataFile) {
  dataFile.println(dataString);
  dataFile.close();
  // print to the serial port too:
  Serial.println(dataString);
}
// if the file isn't open, pop up an error:
else {
  Serial.println("error opening datalog.txt");
}
}
}

void pars_data() { //separate method to call for EC sensor
  EC= strtok(EC_data, ",");
  TDS= strtok(NULL, ",");
  Serial.print("EC:");
  Serial.println(EC);
  Serial.print("TDS:");
  Serial.println(TDS);
  Serial.println();
}

void ECrelayswitch() { //separate method for opening and closing relay switch
  EC_float = *EC;
  if (*EC > 2500) {
    digitalWrite(relay1, LOW);
    tone(4, 3000);
    delay(5000);
    digitalWrite(relay1, HIGH);
    noTone(4);
  }
  else if (*EC < 2300) {
    digitalWrite(relay1, HIGH);
  }
}

```

}

13.7.

NASA X-HAB

Environmental Design Team

04/30/2015

J.C. Overton M.B. Rogers
P.Q. Storm B.Z. Bennett

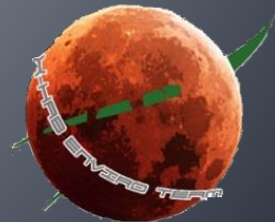

Overview

- X-Hab Team Structure
- Mission and Problem Statement
- Design Concepts
- System Design
- Instrumentation
- Conclusions

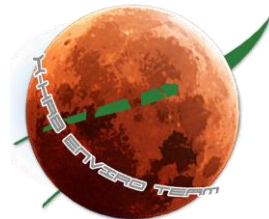

Summary of X-HAB Team

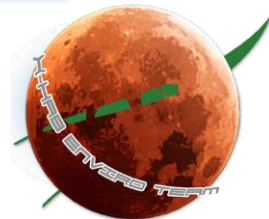
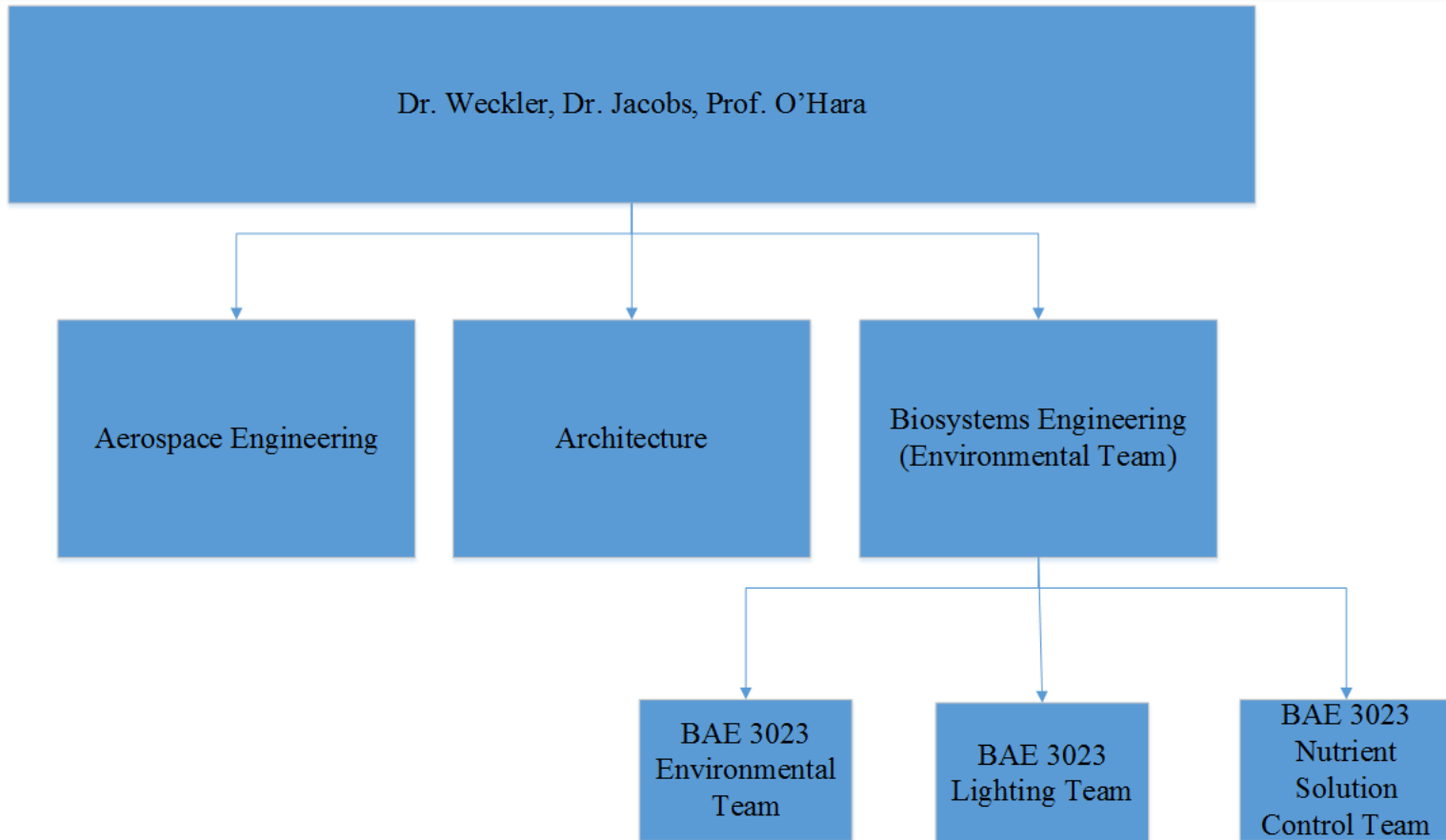

NASA Accountability

- System Definition Review
 - 10/1/2014
- Preliminary Design Review
 - 11/12/2014
- Critical Design Review
 - 1/14/2015
- Progress Checkpoint Review
 - 3/11/2015
- Progress Completion and Evaluation
 - 5/15/2015

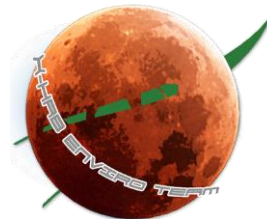

Team Visits

- Stafford Air & Space Museum, Weatherford, OK
- Kansas Cosmosphere and Space Center, Hutchinson, KS
- Marshall Space Flight Center, Huntsville, AL

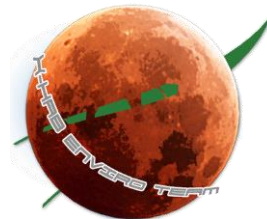

Mission Statement

- Develop fully autonomous greenhouse systems enabling human exploration on the Martian surface
- Develop, integrate, test, and evaluate greenhouse systems that will be utilized as technology test bed and to advance NASA's understanding of alternative mission architectures, requirements, and operations concepts definition, and validation

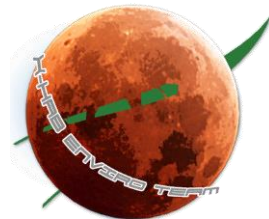

Problem Definition

- Provide dietary supplementation to a four-person crew on the Moon or Mars
- Self-sustaining, collapsible, and lightweight design
- Automated control systems must be used where possible to reduce man hours required for operation

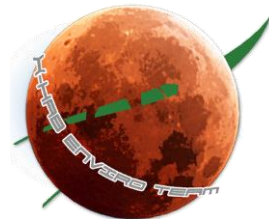

Customer Requirements

- Provide supplemental diet for crew of four (4) for up to 500 days
- Infrastructure Assembly
 - Systems must be deployable in conjunction with deployment of GreenWings
- Area
 - NASA requires the total structure to be less than 75 m² per person (300 m² total)

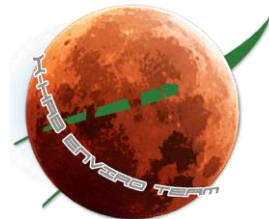

Preliminary Concepts

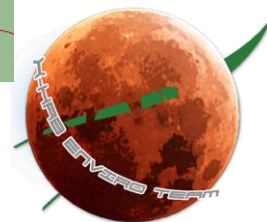
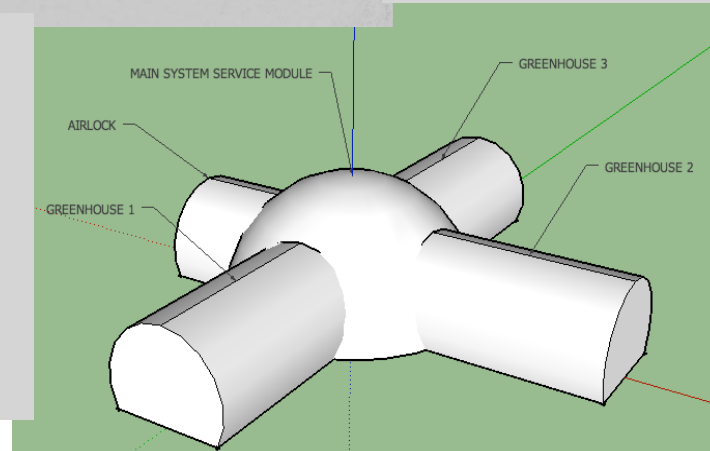
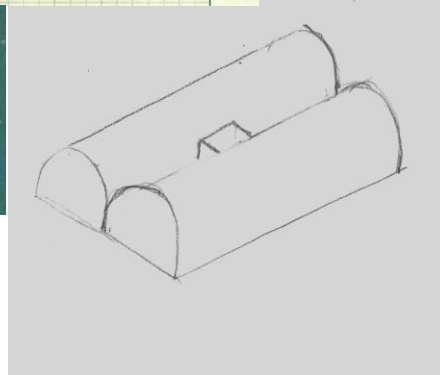
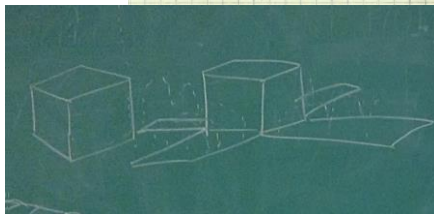
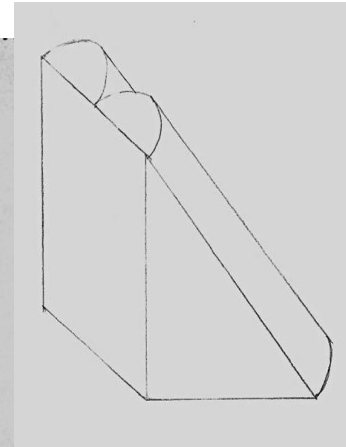
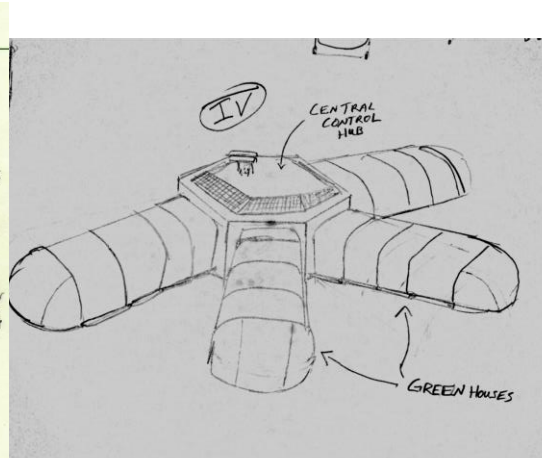
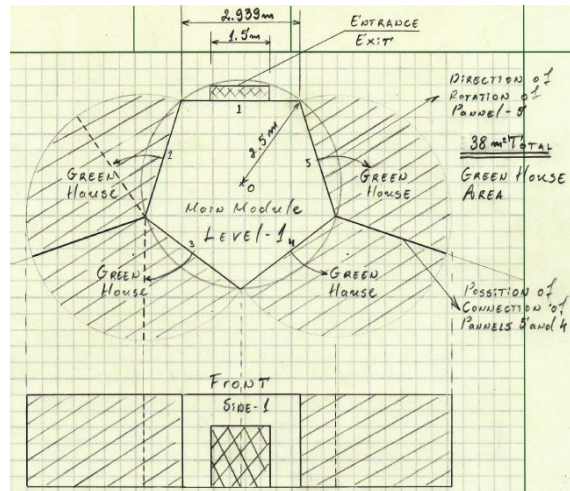

Preliminary Concepts

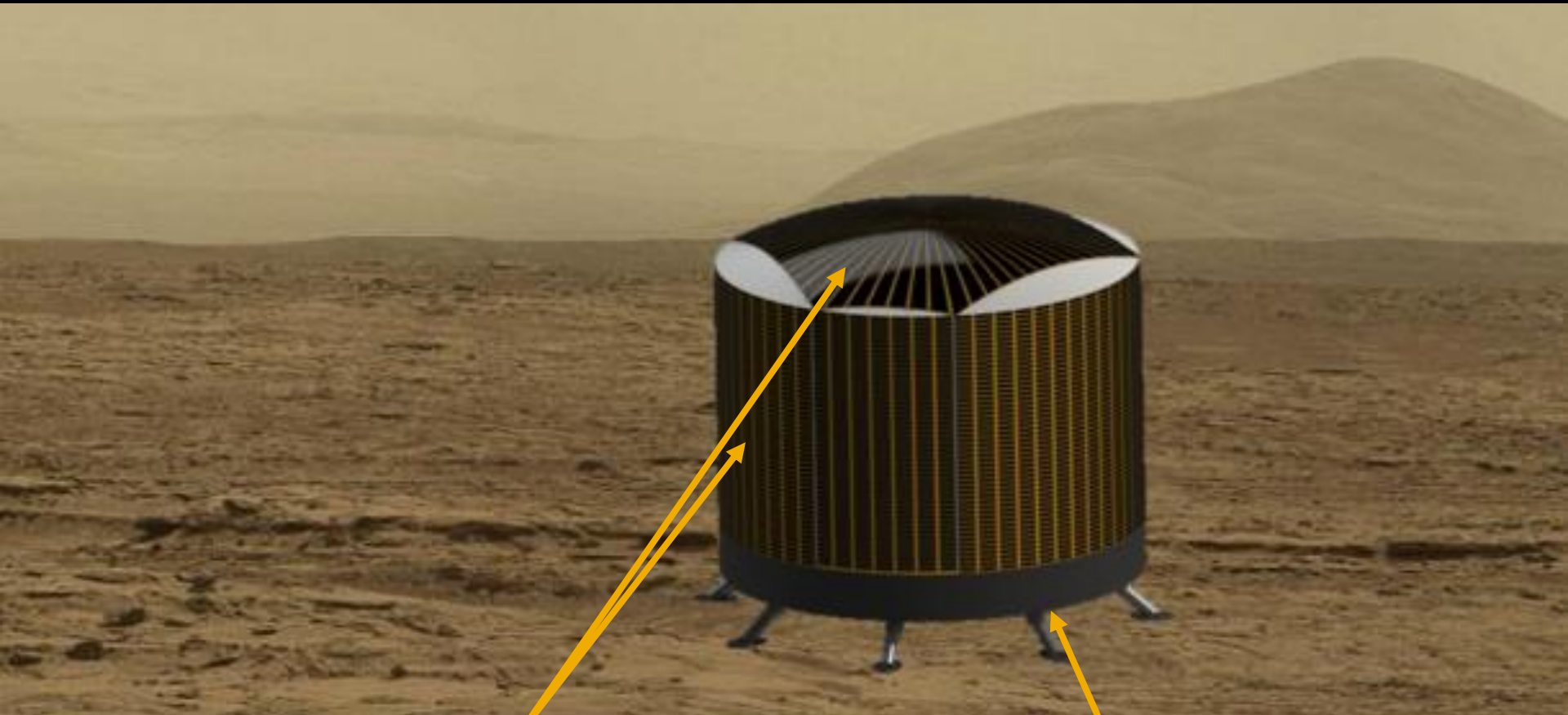

Solar Panels not deployed

Legs

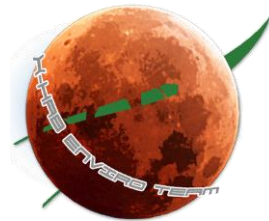

Preliminary Concepts

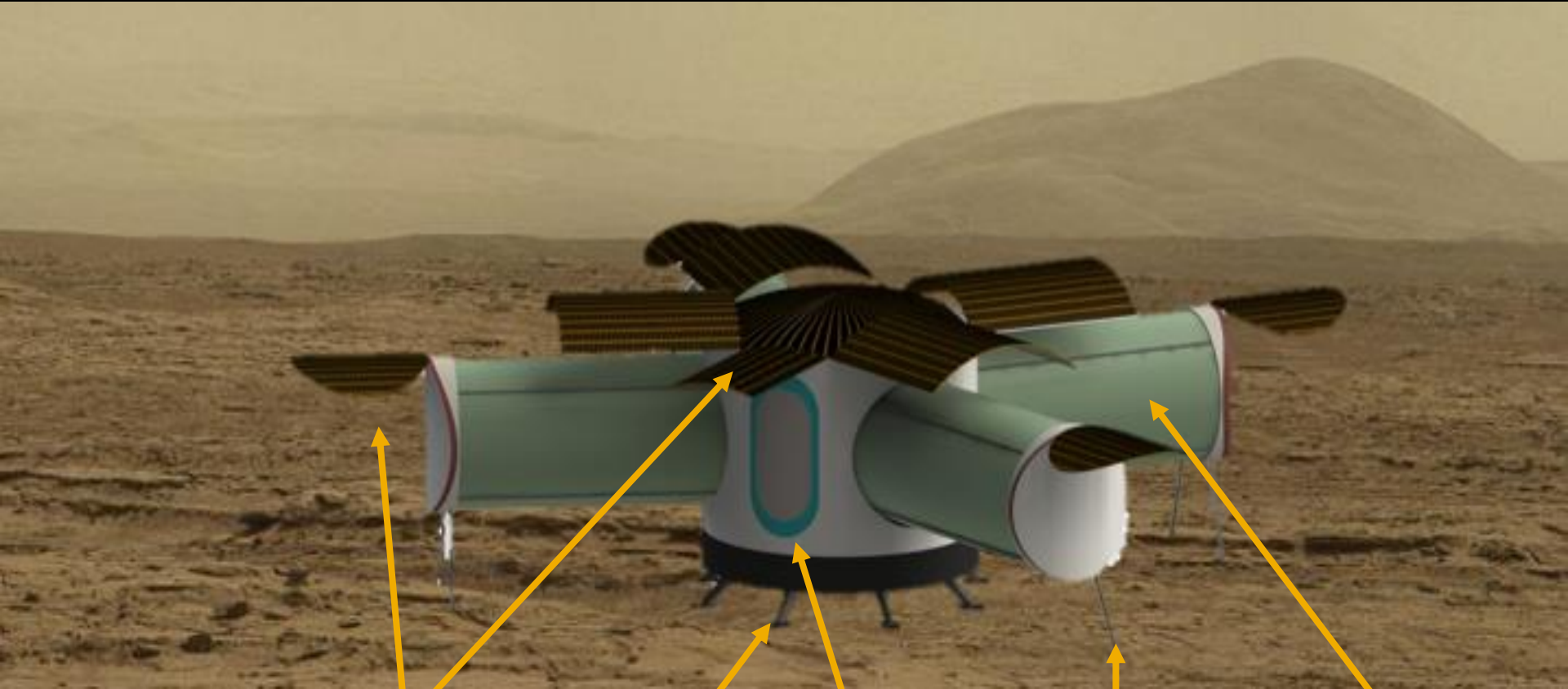

Solar Panels Deployed

Legs

Air Lock

Cast Piles

Greenwings

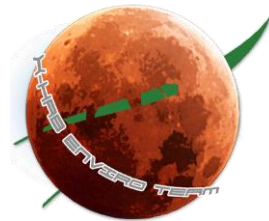

Design Criteria and Overview

- Growing System
 - Minimize space
 - Maximize efficiency
 - Adaptable
 - Independent nutrient/watering regimes

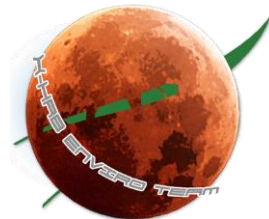

Comparison of Design Options

Aquaponics	
<p style="text-align: center;">Advantages</p> <p>1) Could be made into a closed loop system with little outside input. 2) Little growth Medium required</p>	<p style="text-align: center;">Disadvantages</p> <p>1) Requires large fish population to support plant growth 2) Requires large amount of water for system maintenance</p>
Hydroponics	
<p style="text-align: center;">Advantages</p> <p>1) Very little growth medium required 2) Cheaper than Aeroponics</p>	<p style="text-align: center;">Disadvantages</p> <p>1) Nutrients must be supplied to the system 2) Requires large amount of water for system maintenance</p>
Aeroponics	
<p style="text-align: center;">Advantages</p> <p>1) Efficient water usage. 2) No growth medium required. 3) Allows simple customization of nutrient delivery to each plant type</p>	<p style="text-align: center;">Disadvantages</p> <p>1) Higher operating pressure could cause leaks. 2) System failure must be corrected within 2 hours</p>

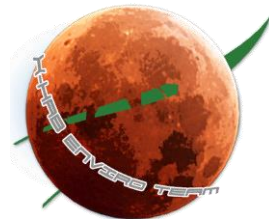

Final Design

- **Aeroponic Growing System**
 - Low nutrient consumption
 - Uses non-organic nutrient supplements
 - Increases gas transfer at roots
 - Highest productivity
 - Requires high pressure (85 to 150 PSI) for 10-50 μm droplets
 - Higher risk of plant death with power loss

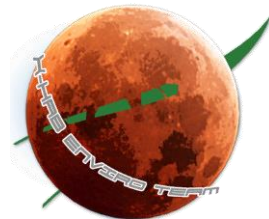

Aeroponic Growth System

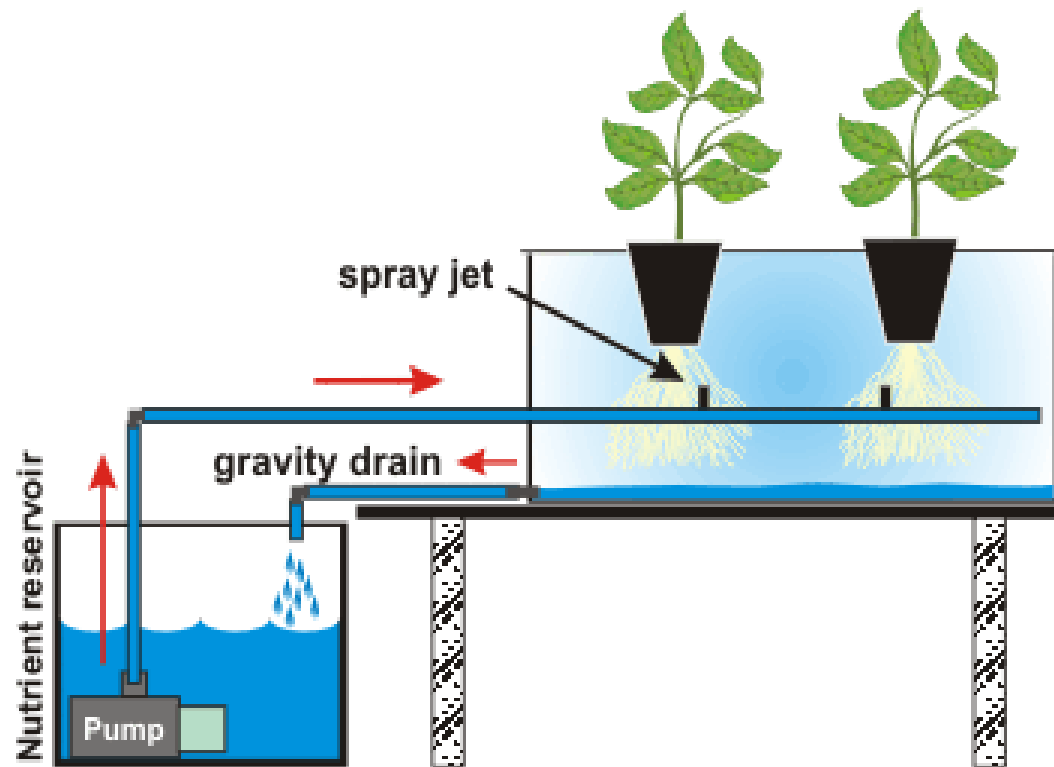

http://www.flairform.com/hints/aeroponic_system_popup.gif

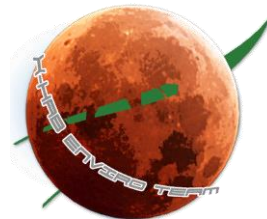

Aeroponic Growth System

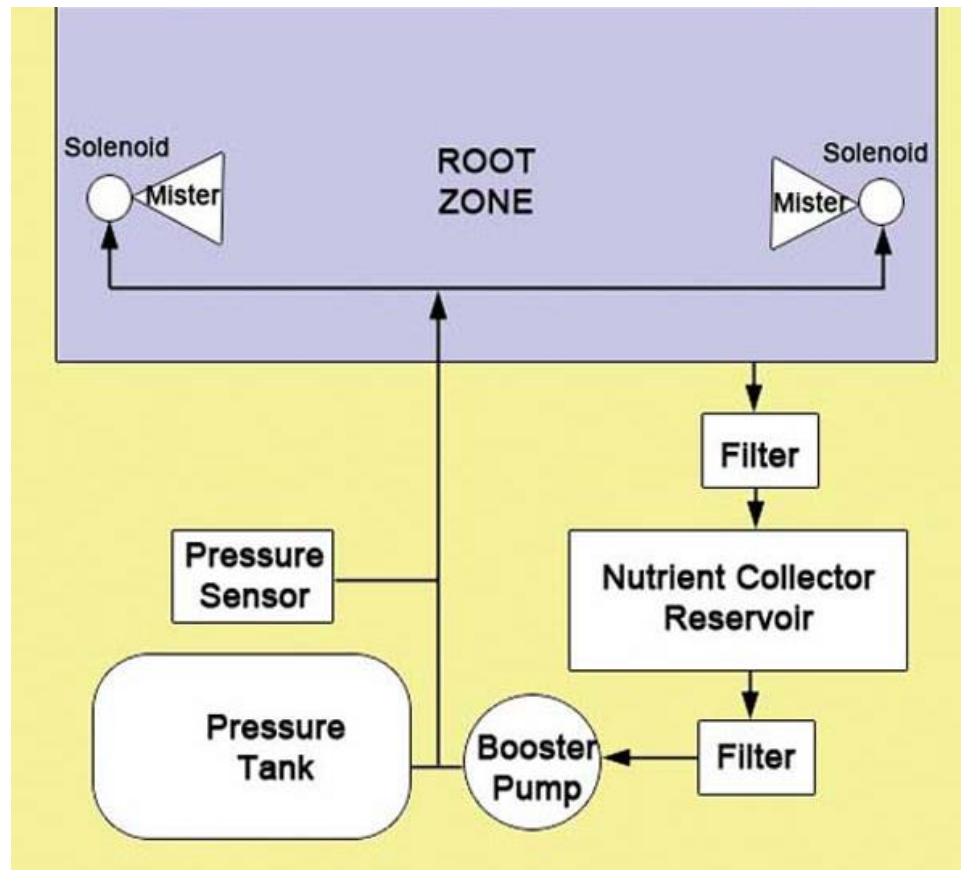

<http://aeroponicsdiy.com/wp-content/uploads/aeroponics-flowchart.jpg>

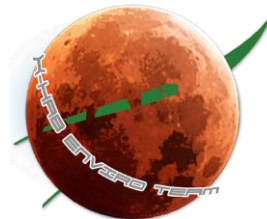

System Design

Deployable System Schematic

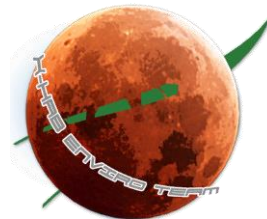
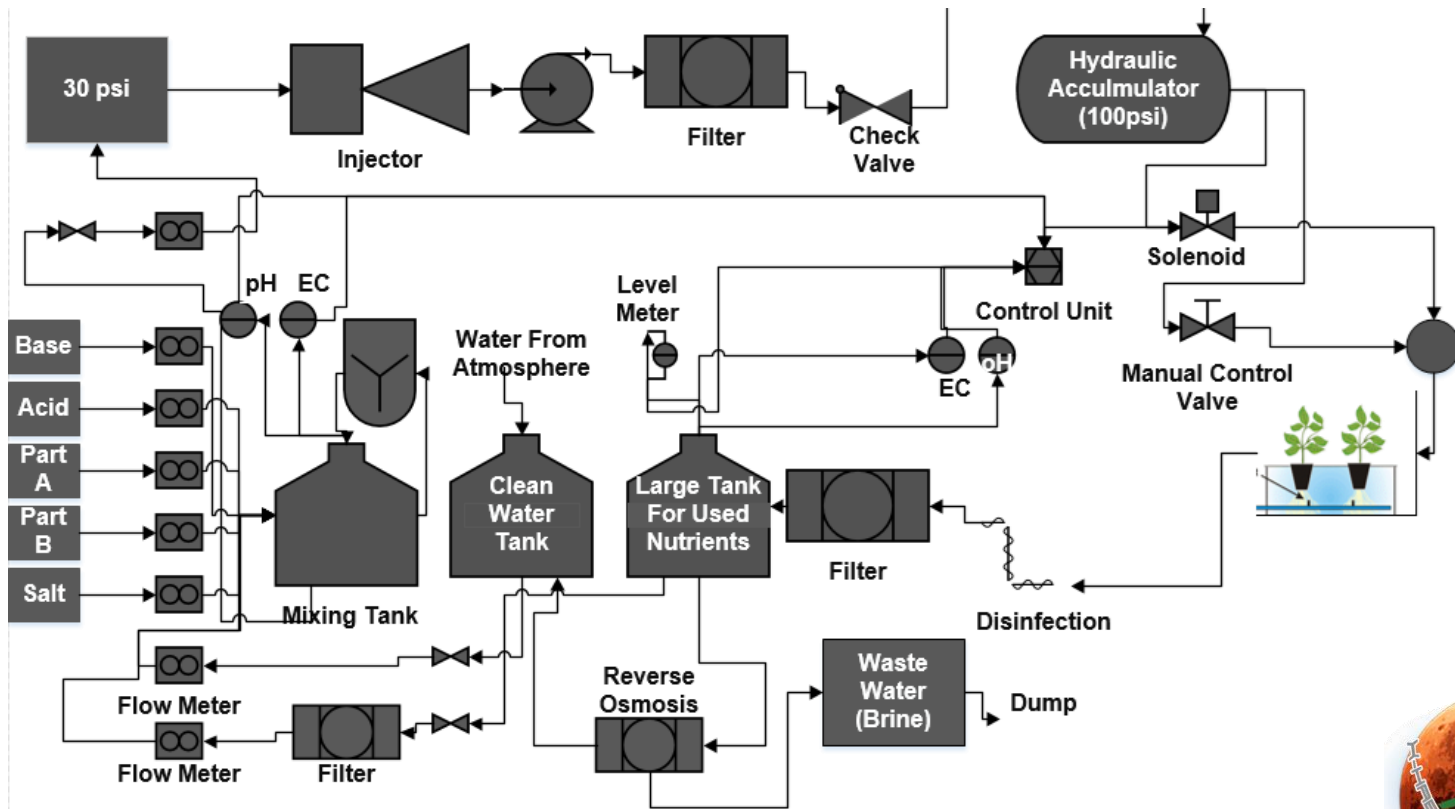

System Design

■ Nutrient Solution (NS) Distribution

■ Bladder Tanks

- Stores NS at 100 psi
- Located at end of each row
- Can be used in power outage

- Controller used to distribute NS to bladder tanks in GreenWing

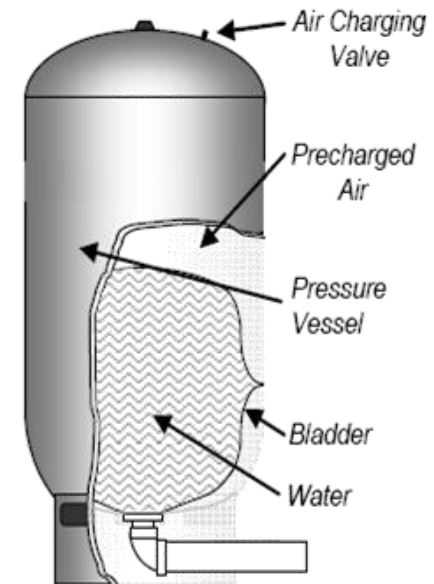

Bladder Pressure
Tank

<http://www.apswater.com/images/bladder-operation2.jpg>

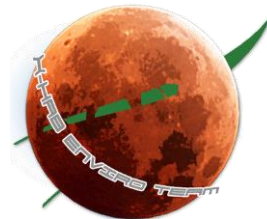

System Design

- Reused Nutrient Solution Monitoring
 - EC and pH used to monitor nutrient solution
 - pH range of 5.5 to 6.5
 - EC_{max} plant species and plant stage dependent (2300 to 2500 μS)
 - Reused nutrient solution volume reduced ~50% when $EC > EC_{max}$

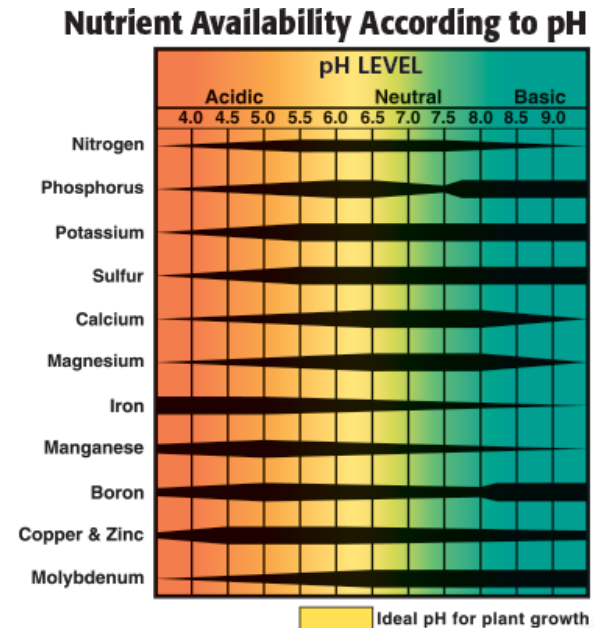

<http://blog.100bulbs.com/wp-content/uploads/2014/10/phelements.png>

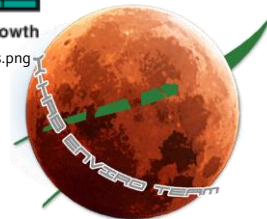

System Design

- Nutrient Solution Water Reclamation
 - Water condensed from GreenWing atmosphere
 - Reverse Osmosis system used to filter out nutrient solution
 - Treated water returned to water supply
 - Frequency dependent on salt buildup rates
 - Brine waste removed

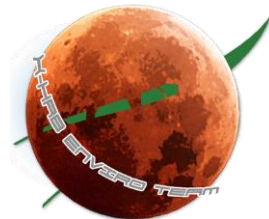

Crop Selection

- Plants selected for both aeroponic growing capabilities and low maintenance requirements
- Numerous crops considered
 - Sweet Potato
 - Okra
 - Wheat
 - Quinoa
 - Rice
 - Lettuce
 - Spinach
 - Chard
 - Broccoli
 - Carrots
 - Cucumber
 - Radish
 - Snap Peas
 - Strawberries
 - Blackberries
 - Onions
 - Cauliflower
 - Green Beans
 - Onions
 - Tomato

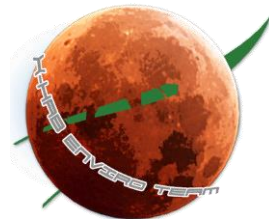

Crop Selection

- Leafy Greens: Lettuce, Spinach
- Vegetables: Carrots, Onions, Cucumber, Radish, Snap Peas
- Fruits/Berries: Strawberries, Blackberries



Redgardens.com



Plantfinder.com



Burpee.com

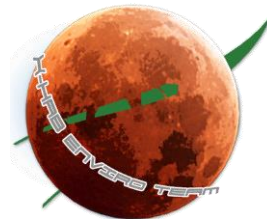

RVI: Selected Crops Average

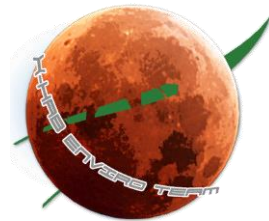
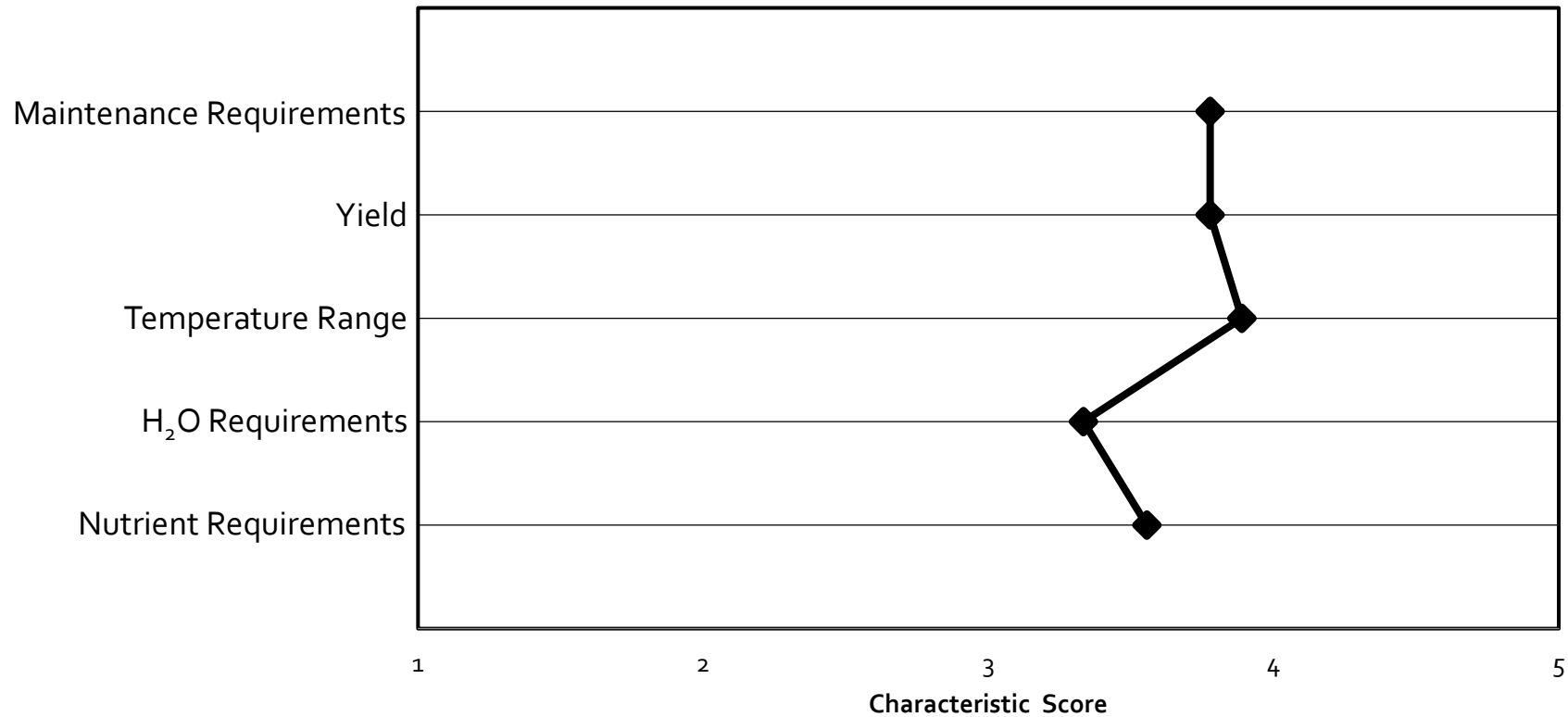

Planting Schedule

Plant	Designated Wing	Required Spacing (ft)	Time to maturity (Days)	Planting Interval (Days)	Plants/year
Snap Peas	1	0.5	60	2	150
Cucumber	1	1	70	2	150
Onion	1	0.5	120	4	75
Lettuce	2	0.5	60	1	300
Carrots	2	0.25	70	1	400
Spinach	3	0.33	60	3	120
Radish	3	0.5	35	2	150
Strawberry	4	3	-	-	7.5
Blackberry	4	4	-	-	5

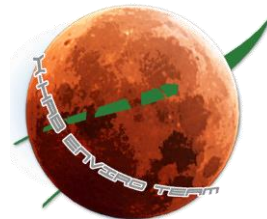

Analog Testing

- Four analogs to test various readiness levels
 - Small-scale aeroponics system
 - Nutrient solution instrumentation
 - Lighting system controls
 - Environmental monitoring

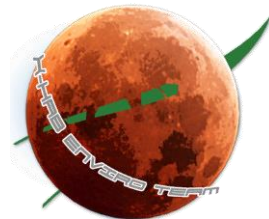

Small Scale Aeroponics

- 20 plant test unit at ARS greenhouse
 - In situ germination had low germination rate
 - Coffee filter germination was successful

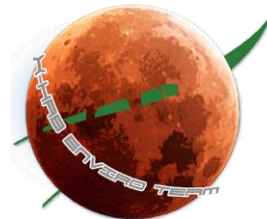

Small Scale Aeroponics

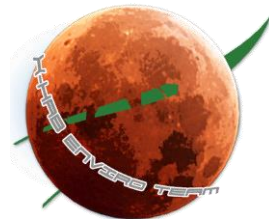

Full Scale GreenWing Analog

- In conjunction with the Aerospace design team a 16 foot section of GreenWing was constructed

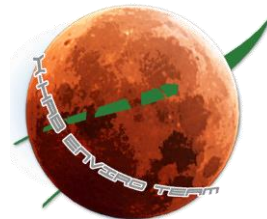

Nutrient Solution Instrumentation

- Monitored pH and electroconductivity in the mixing tank
- Mixes, distributes, and recycles nutrient solution to aeroponics system

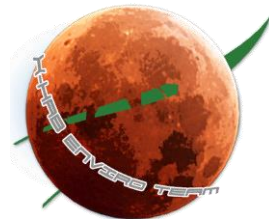

Nutrient Solution Instrumentation

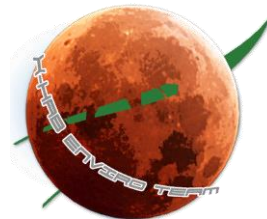
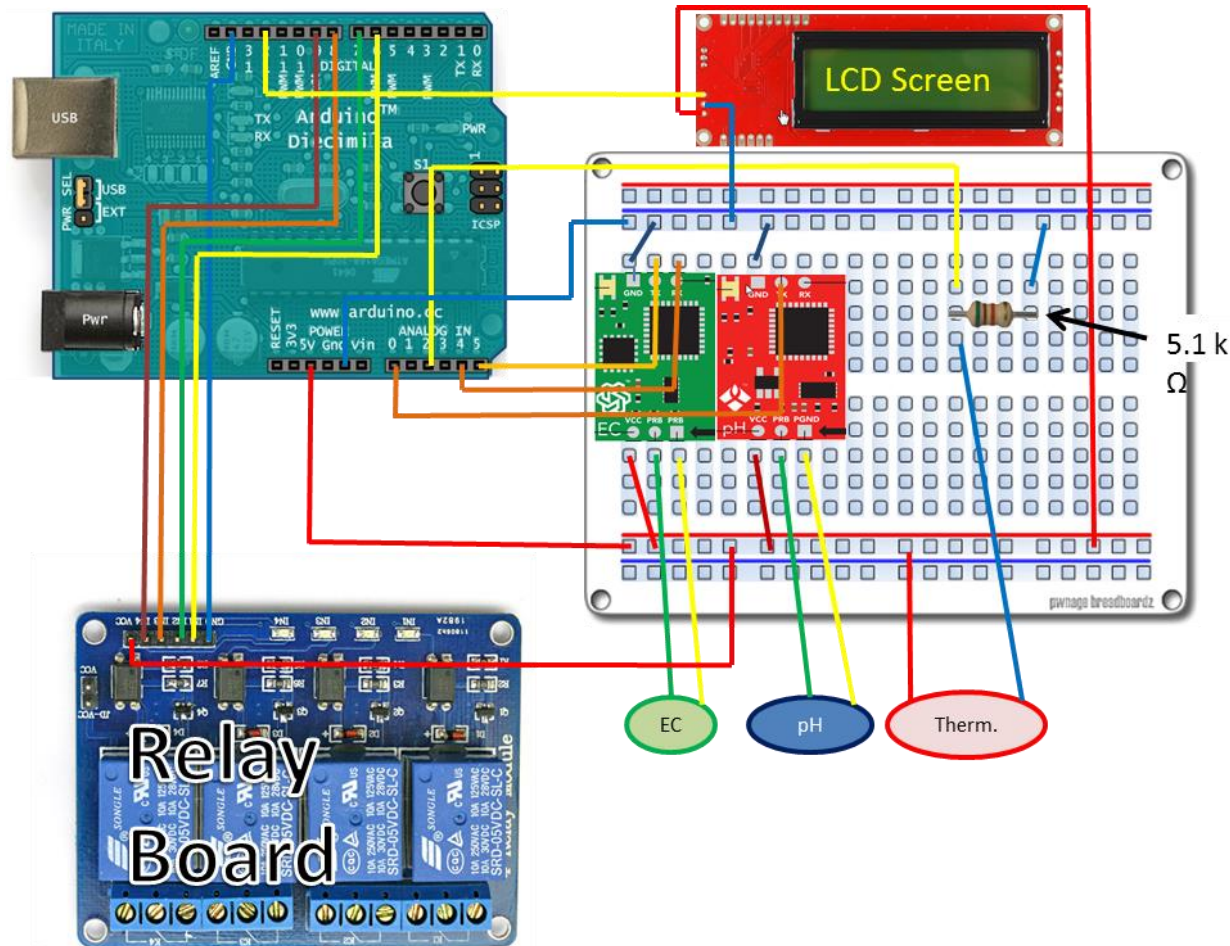

Nutrient Solution Instrumentation

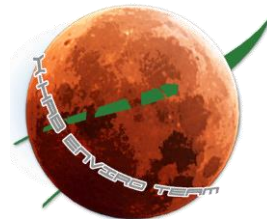
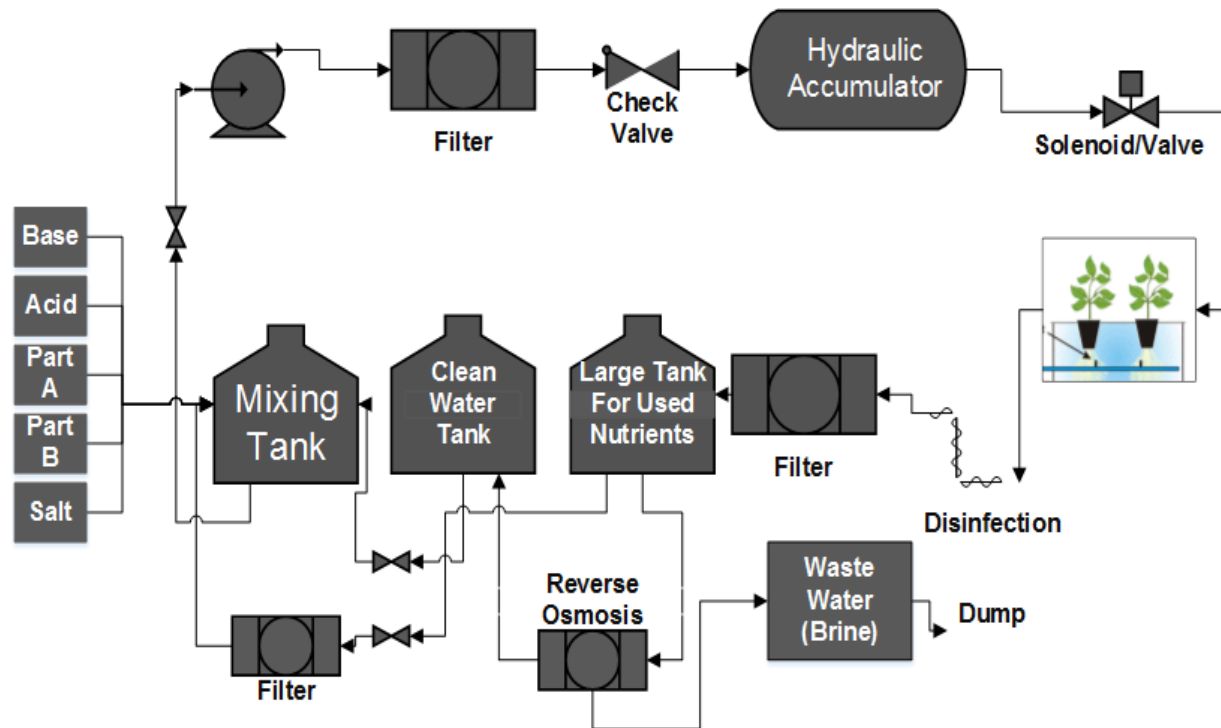

Nutrient Solution Instrumentation

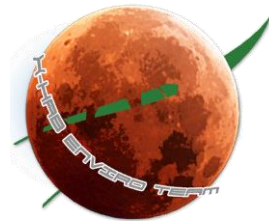
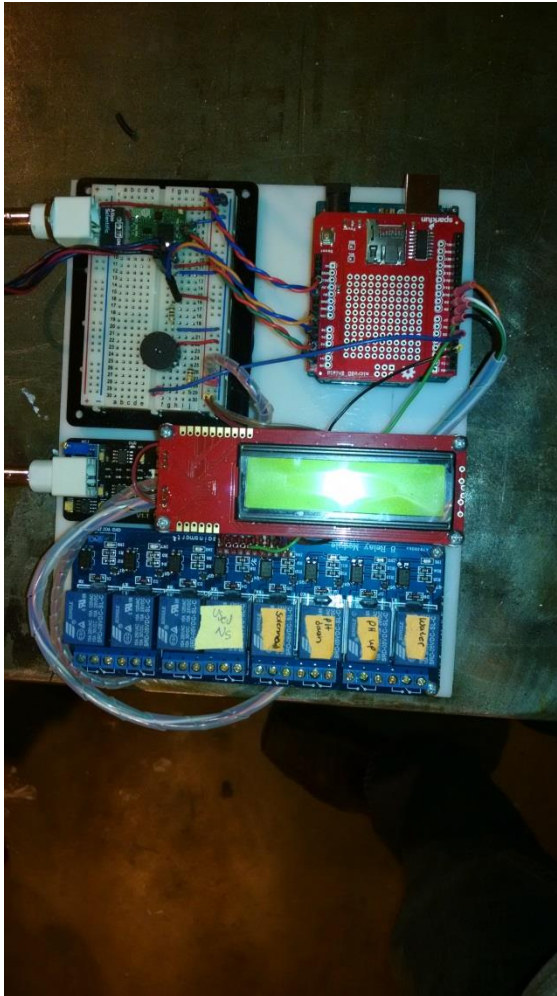

Lighting Controls

- Interface to automate lighting cycle for specific crops
- Allows for operator to input crop selection into specific lighting array for each row

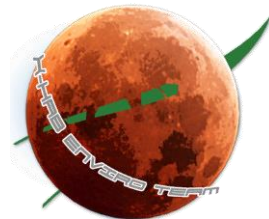

Lighting Controls

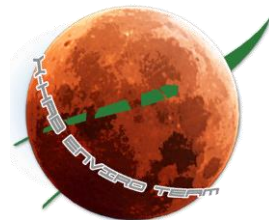
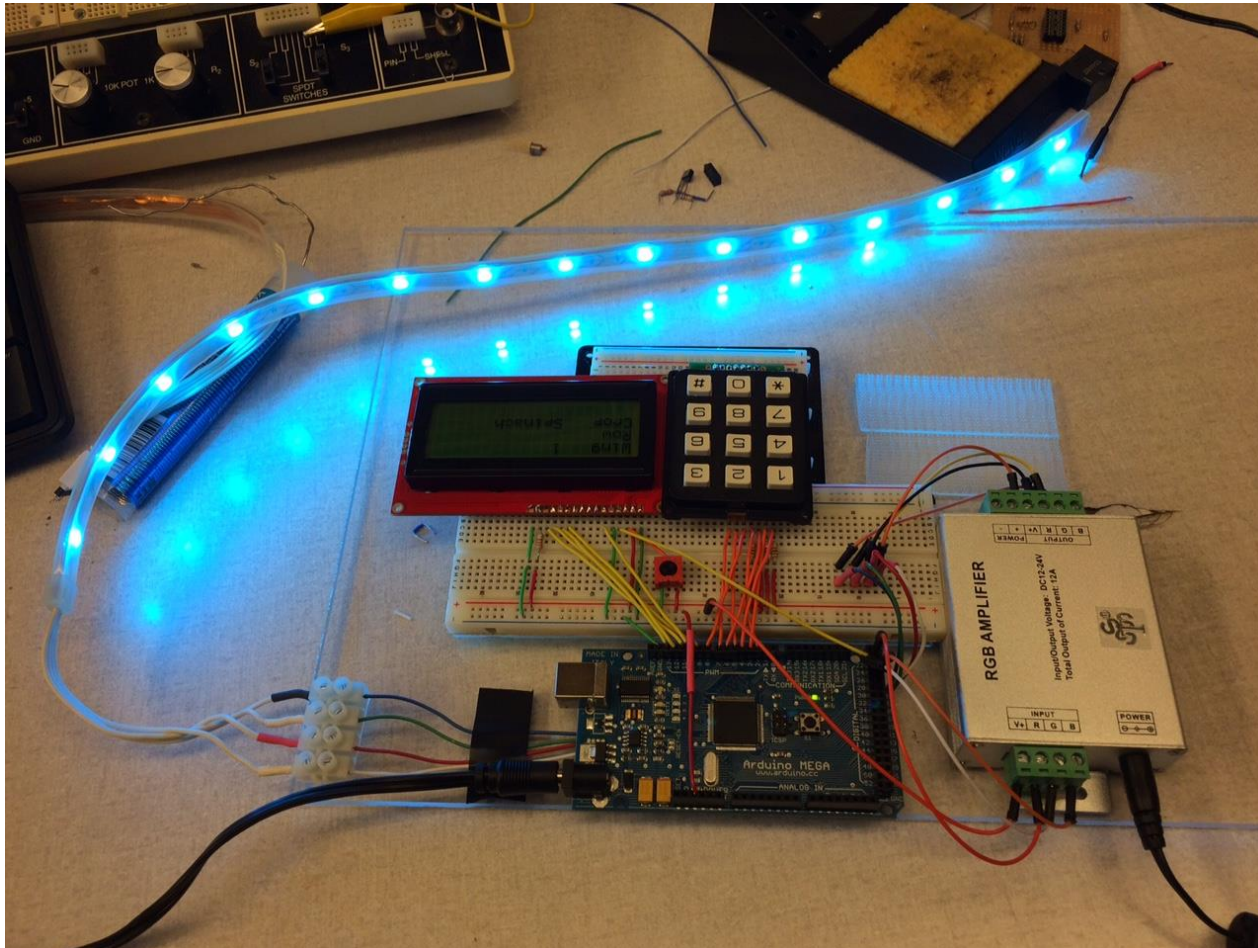

Environmental Sensors

- Monitors air temperature, humidity, lighting intensity, and pressure
- Sounds alarm if values are outside of acceptable ranges
- One probe inside aeroponics, one outside of aeroponics system

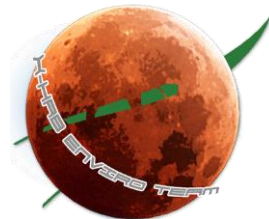

Environmental Sensors

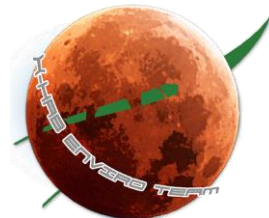
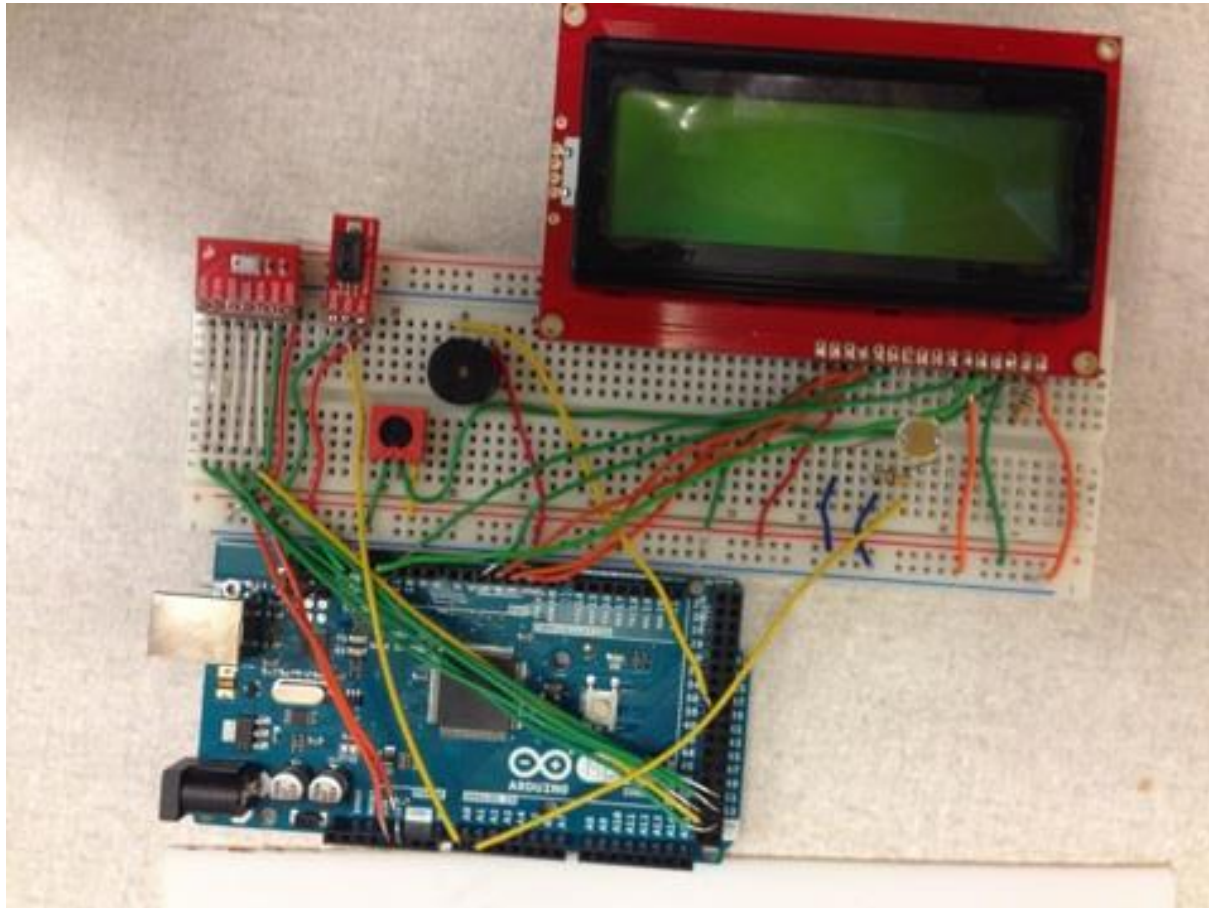

PICTURE OF GREENWING

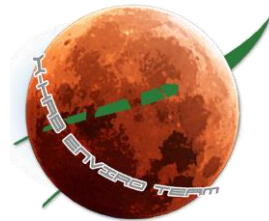

PICTURE OF GREENWING

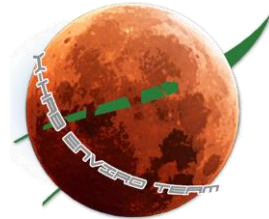

Conclusions

- In conjunction with Aerospace Engineering, Architecture, and Electrical Engineering a space rated design was developed
- The systems to monitor the composition and distribution of nutrient solution were developed successfully
- More studies need to be done on sustained growth past germination
- A full-scale, functioning analog was constructed

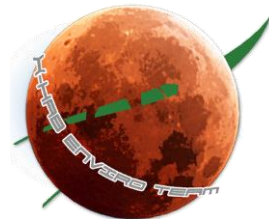

Acknowledgements

- Drs. Bellmer, Dunford, Fox, Henley, Jacob, Jones, Long, O'Hara, Penn, Reid, Storm, Taylor, Vogel, Wang, Weckler
- Aerospace Eng., Architecture, Electrical Eng.
- BAE 1012 Research Groups
- BAE 3023 Instrumentation Groups
- NASA
 - Tracy Gill, Morgan Simpson, Kelly Gattuso, Raymond Wheeler, Gioia Massa
- National Space Grant Foundation
- Wayne Kiner and crew
- Austin Mitchell

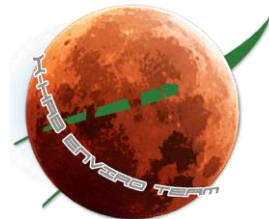

Questions

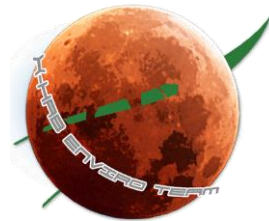

X-Habitation (X-Hab) Deployable Greenhouse
Environmental Design Team

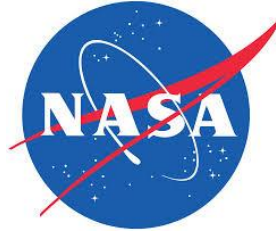
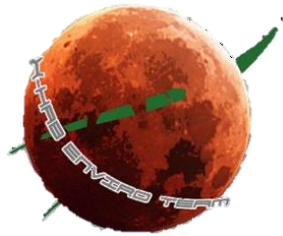

Greenhouse Systems for Deployment on Mars

Senior Design Project
Biosystems & Agricultural Engineering
Fall Semester Report
December 5, 2014

Bryant Z. Bennett

Matthew B. Rogers

Jonathan C. Overton

Peter Q. Storm

Partnered with: National Aeronautics and Space Administration

Table of Contents

1. Statement of Problem	3
2. Customer Requirements.....	4
3. Team Requirements	6
4. Technical Analysis and Literature Review	7
5. Relevant Patents.....	9
6. Previous designs	13
7. Engineering Specification.....	15
8. Design Concepts	17
9. Selection and Description of Design	21
10. Risk Analysis.....	31
11. Project Schedule	38
12. Project Budget.....	41
13. Environmental and Societal Impact.....	42
15. References Consulted	45
16. Appendices	49

List of Tables

Table 1: Atmosphere Requirements	15
Table 2: Maximum Expanded Shelving Dimensions (meters).....	16
Table 3: Calculation Table for Production of Required Ammonia	18
Table 4: Advantages and Disadvantages of Different Plant Growth Systems	20
Table 5: Plants considered for use in the Green Wings	28
Table 6: Estimated Budget for Prototyping	41
Table 7: Estimated Budget for NASA Mission	41

Partnered with: National Aeronautics and Space Administration

List of Figures

Figure 1: Preliminary Shelf Design	7
Figure 2: Origami 156-793	7
Figure 3: Typical trickle bed reactor design	13
Figure 4: Block diagram for a closed-loop aquaponics system.....	17
Figure 5: Typical hydroponic system set-up	19
Figure 6: Smart Fertilizer GUI displaying the potential chemicals to create a nutrient solution and the nutrient data for a plant.	23
Figure 7: Overview of nutrient solution recirculation system.....	26
Figure 8: Overview of nutrient solution recirculation system and the associated instruments and controls.	26
Figure 9: Shows the RVI for each of the leafy greens.....	29
Figure 10: Shows the RVI for each of the considered cool season crops	29
Figure 11: Shows the RVI for each of the warm season crops	30
Figure 12: Shows the average RVI of each of the selected plant species.....	30
Figure 13: Gantt Chart	38

1. Statement of Problem

In conjunction with the Aerospace Engineering design team, the systems and structures necessary to supplement the diet of a four-man mission to Mars for at least 500 days will be designed. The systems and structures will be designed with future additions in mind, requiring modular and extended use capability. In all aspects of the project, the issue of safety is paramount. On Mars, a systems failure will almost undoubtedly end in loss of life, equipment, and investment. It is a priority of the team to ensure that systems are reliable and properly functioning. It will also be ideal that the system design be as autonomous as possible. With a four-man team, all man-hours will be crucial to the development of knowledge pertaining to Mars, and more time spent operating and maintaining food production systems will result in less available time for scientific research or other advancement. Automation systems will be developed in conjunction with BAE 3023 (Instrumentation and Controls in Biosystems Engineering). The selection of a biological production system to fill the greenhouse design of the NASA X-Hab Greenhouse Structures Team (Aerospace Engineering) will be conducted by the NASA X-Hab Environmental Team (Biosystems Engineering). The plants selected must be sufficient to supplement a four-man crew on the Moon, Mars, or similar bodies. In addition, the rotation of planting and harvesting must be sufficient to provide continuous production for 500 days.

2. Customer Requirements

2.1. Project Overview and System Design Review (SDR)

The National Aeronautics and Space Administration (NASA) have requested that the design provides a supplementary diet for a Mars or lunar mission of up to 500 days with a crew of 4 to 6 people. NASA stipulated that we focus on non-essential foods such as lettuce, tomato, berries, and spices (Raymond Wheeler, NASA, personal communication, September 19, 2014). Crops selected must also have minimal processing requirements and need little additional infrastructure to support and sustain growth. In addition, NASA further stipulated that a hydroponic growth system was their preferred option and that testing plant growth in Martian regolith analogs was likely out of project scope. NASA estimated that 50 m² would be needed per crew member for plant growth (Raymond Wheeler, NASA, personal communication, September 19, 2014). Finally, NASA stated that water would likely need to be recycled from evapotranspiration to ensure a sustainable rate of water consumption (Raymond Wheeler, NASA, personal communication, September 19, 2014).

2.2. Preliminary Design Review (PDR)

After a preliminary design presentation, the NASA scientists provided additional requirements, expectations, and concerns about the project progress. Dr. Massa suggested that the cold Martian atmosphere be used to condense water loss to evapotranspiration in the greenhouse. These systems could be incorporated into the wall structure of the GreenWing. Dr. Wang also suggested that sterilization systems be put in place to reduce the chances of microbial or insect infection of

plant species. Special care would be needed to prevent the formation of biofilms, which would lower mass transfer coefficients and are difficult to remove without scrubbing.

3. Team Requirements

The Environmental Team has imposed additional requirements due to open-ended project requirements from NASA. The Environmental Team will be designing the systems necessary to provide a four man crew with additional dietary diversity. Nutrient input required from outside of the system should be kept to a minimum. The lighting system will be fully automated and optimized for the growth and maintenance of plants. All designs will take into account energy consumption and be designed to require minimal energy input. All support structures such as shelving and piping must be easily collapsible to reduce the required stowage volume for transport. Shelving must also be on tracks to allow the addition of an extra row of growing plants without reducing the accessibility of all plant rows. Each additional pound in a design will result in a \$10,000 cost increase, therefore requiring all designs to be as light as possible.

4. Technical Analysis and Literature Review

For the deployable greenhouse, the aerospace design team requested that the Environmental Team develop a deployable shelf with outer dimensions of 2.0 m x 0.6 m x 2.5 m (l-w-h). A preliminary telescopic design has been developed that meets these outer dimensional requirements (see Figure 1 for the preliminary drawing). In addition, the shelf will be collapsible to approximately 0.5 m x 0.6 m x 0.5 m. The shelf will move on a tracking system that will be built into the flooring of the greenhouse. A heavy-duty canvas material will be stretched across the rails to rest growth structures. To secure the telescoping sections, spring loaded button mechanisms will deploy out of pre-drilled holes when the shelf is expanded to full dimensions. Structural analysis will be conducted on this design to ensure shelf strength and stability. Moreover, current shelving designs may also be considered. Many shelves use a folding middle portion such as the Origami 156-793 shown in Figure 2. In addition, an irrigation system is being developed that will be integrated into the shelving to water the plants.

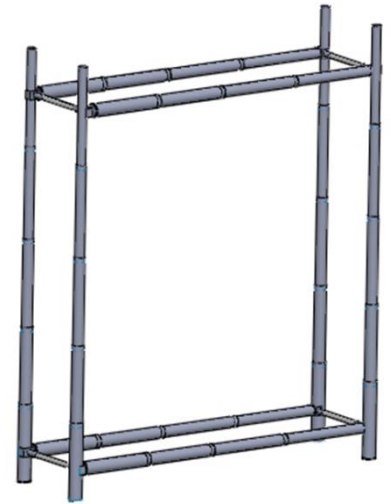

Figure 1: Preliminary Shelf Design



Figure 2: Origami 156-793

To provide supplemental calories for future Mars missions, an aeroponics system is being developed. Many patents offer designs as to how to make an aeroponics system and the patents are discussed in the patents section of this report (Section 9). Peterson and Kruger have found that an aeroponics system can successfully grow cucumbers with good root branching and development. Their system remained fully operational for 32 weeks without a malfunction. In addition, Nir has found that an aeroponics system can successfully grow vegetables (tomato, pepper, cucumber, lettuce, etc.) as well as ornamental plants and fruit trees.

5. Relevant Patents

5.1. Aeroponic System and Method

US 20140137471 A1

Accessed: Google Patents 11/29/2014

Abstract:

Exemplary embodiments are directed to an improvement of an aeroponic system including a growth chamber and cloth support elements. The improvement generally includes a cloth supported by the cloth support elements. The cloth advantageously satisfies a wicking height parameter and an absorbance parameter so as to deliver advantageous aeroponic performance. The wicking height parameter is a measurement of an ability of the cloth or fabric to absorb moisture. The absorbance parameter is a measurement of moisture the cloth or fabric retains. Exemplary methods of aeroponic farming in an aeroponic system are also provided.

Relevance:

This patent describes a way of setting up aeroponics system and growing plants. Cloth is used as an absorbance media for plant nutrients as well as prohibits pooling of nutrient solutions, preventing seed drowning. The seed is placed on the cloth and then germinates, allowing the roots to break through the cloth. Cloth may be considered or at least acknowledged during the design of our aeroponic system.

5.2. Automated aeroponic plant growing system

WO 2014102553 A1

Accessed: Google Patents 11/29/2014

Abstract:

A fully automated aeroponic plant growing system, is monitored and controlled by only a central digital automatic operation unit for all the individual parts and on line monitoring capability. It has the ability to simultaneously support multiple aeroponic crops or growing treatments with different nutritional requirements, or only one aeroponic crop. Simultaneously prepares, sterilizes and controls all individual and different nutrient solutions needed to feed plants, which are sprayed onto the roots through the recirculation support system. It has the ability to control and adjust at any given value the root zone atmosphere temperature into growing chambers or vessels, by monitoring and controlling the temperature of nutrient solution sprayed to the roots, offering ideal root growth conditions to grow plants. This is made entirely of suitable insulating material, Capable to support parallel or not, all known hydroponic and Aeroponic cultivation systems and suitable for any open or closed environment.

Relevance:

This patent employs a digital automation operation unit to control all aspects of the aeroponic growing system. The monitoring and automated aspects that the patent describes (nutrient monitoring, lighting, and watering frequencies) are areas that the Environmental Team plans to incorporate into the final design.

5.3. Modular Automated Aeroponic Growth System

US 20140144078 A1

Accessed: Google Patents 11/29/2014

Abstract:

An aeroponic growth system comprising a plurality of modular aeroponic units each including at least one spray nozzle directed into a root zone; a lighting system associated with the plurality of the modular units and configured for emitting light in a vegetative zone; a pressurized reservoir configured for housing a nutrient containing fluid; and a nutrient feeding system configured for fluidly and selectively connecting each of the modular units to the pressurized reservoir in parallel, wherein the nutrient feeding system includes a pressure stop valve associated with each of the modular units. When one of the modular units are disconnected to the associated pressure stop valve, the pressure stop valve is configured for preventing the fluid from flowing from the pressurized reservoir through the pressure stop valve, and the other modular units connected to the nutrient feeding system remain fluidly connected to the pressure reservoir.

Relevance:

The modular, lighting, nozzle watering, and pressure vessel aspects of the design described in this patent are all relevant to the final design of our aeroponics system. The Environmental team will be considering ways to incorporate all of these aspects to the final design.

5.4. Aeroponic plant growing system

US 7823328 B2

Accessed: Google Patents 11/29/2014

Abstract:

An aeroponic plant growing system includes a water reservoir and growing chambers for growing plants in an aeroponic environment. A pump, a water distribution manifold, and water lines are used to provide water and nutrients from the water reservoir to sprayers in the growing chambers where the water and nutrients are sprayed on the roots of plants growing therein. The water distribution manifold and water lines preferably are provided as closed loop systems, such that water is provided to all sprayers despite a blockage in the manifold or a water line. Non-absorbed water and nutrients are returned to the water reservoir from the growing chambers on water return lines via a filter that includes multiple types of filter media, including filter media that support the colonization of organisms that support plant growth.

Relevance:

This patent describes a closed loop system to provide water to the sprayers and recycle the water back to the reservoir. The returned water is filtered via a filter media that can include bacteria or fungi which adds nutrients to the plants through nitrogen fixation. A closed loop system is being designed by the Environmental Team for the aeroponics system. Organisms in the filter media will be considered or acknowledged as a possible although unlikely design aspect.

6. Previous designs

Past studies have focused on the growth of plants in low light, low pressure, and low nutrient media. A few other studies have focused on the creation of a bioregenerative life support system (BLSS). BLSS creates a loop using the O_2 produced by plants via photosynthesis which is then consumed by humans who in return produce CO_2 via respiration for the plants. However, considering the proposed floor plan with a separate greenhouse and living area, the mass balance loop will be harder to close, as humans will not be consuming O_2 and producing CO_2 in the same space as the plants.

In order to overcome this issue, a preliminary aquaponic design concept was created for supplementation of diets on Mars. This system was designed to be as self-sufficient as possible, using waste product from each subunit to supply other subunits with nutrients. Kitchen waste and miscellaneous waste biomass would be used to

feed fish in conjunction with dry protein pellets to increase health. The fish would excrete ammonia and solid waste. The ammonia would be oxygenated by nitrogen-oxidizing bacteria, converting highly toxic ammonia to nitrite, which would then be converted to nitrate, a compound easily consumed by plants and less toxic to fish. This conversion would occur in a trickle bed reactor (Figure 3) packed with solid beads to assist the formation of biofilm. The solid waste would be separated using a settling tank, and then be dried, ground, and mixed with

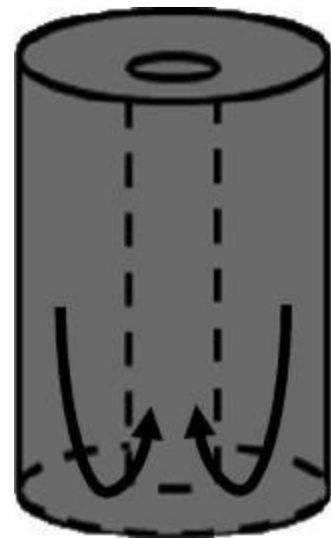

Figure 3: Typical trickle bed reactor design

other biomass to fertilize plants in the grow bed. In addition, algae would be grown in a separate reactor to provide large amounts of O₂, as well as nutrient rich biomass for use as fertilizer. Based on previous research, column reactors are the best reactor type due to photosynthetic efficiency and areal productivity (Kunjapur and Eldridge 2010). Figure 3 shows a column reactor.

7. Engineering Specification

7.1. GreenWing Atmosphere Requirements

The atmospheric conditions required for plant growth are shown in Table 1.

These conditions must be met at all times in order to maintain plant life.

Table 1: Atmosphere Requirements

Oxygen Partial Pressure (kPa) (MAE)	> 5
Oxygen (% at atmospheric conditions) (MAE)	13-50
Carbon Dioxide (ppm) (OSHA)	< 1000
Atmospheric Temperature (°C)	18-24

7.2. GreenWing Shelving Requirements

Expanded shelving to be used in the greenhouse must have two shelves and be able to slide on recessed tracks for ease of plant access from either side of the shelving unit. Shelving must be capable of being collapsed as small as possible for transport, and expand automatically during the greenhouse deployment phase to the dimensions listed in Table 2. The environmental team will be working with the structures team to create a shelving system that is deployable through inflation in conjunction with the deployment of each GreenWing. The inflatable shelving system would also have the pipes and nozzles necessary for the aeroponic system.

Table 2: Maximum Expanded Shelving Dimensions (meters)

Length	2
Width	0.6
Height	2.5

7.3. Aeroponics Assembly Requirements

Spray nozzles must be mounted close to mesh plant cups for even distribution of nutrients on the plant roots to allow for sufficient plant growth. Tubing for the system running from the pump to the nozzles must be flexible and capable of handling pressures up to 100 psi to ensure the tubing doesn't rupture. The pump must be capable of supplying each of the three shelving units.

7.4. Space Availability

NASA has expressed a desire to make the footprint of the whole system as close to 75 m² per person as possible. Based on this specification, the total system area should be no more than 300 m². The structures group will be working to provide a structure that maximizes the area available for growing systems and controls.

8. Design Concepts

8.1. Aquaponics

Aquaponic systems cycle water between fish tanks and plant growth beds. In these systems the ammonia produced by the fish is oxidized to nitrite and nitrate using naturally occurring bacteria such as *Nitrobacter* and *Nitrospira*. The nitrate is less toxic to fish and is capable of being taken up by plants. Aquaponic systems often require additional nutrient input to supply the plants with all nutrients necessary for growth. In an aquaponic system, plant roots are typically in a golf ball sized spherical root media, but can also be fully submerged in a deeper tank. Robust aeration is required to maintain high dissolved oxygen levels at the roots. Figure 4 shows a block diagram of a closed loop aquaponics

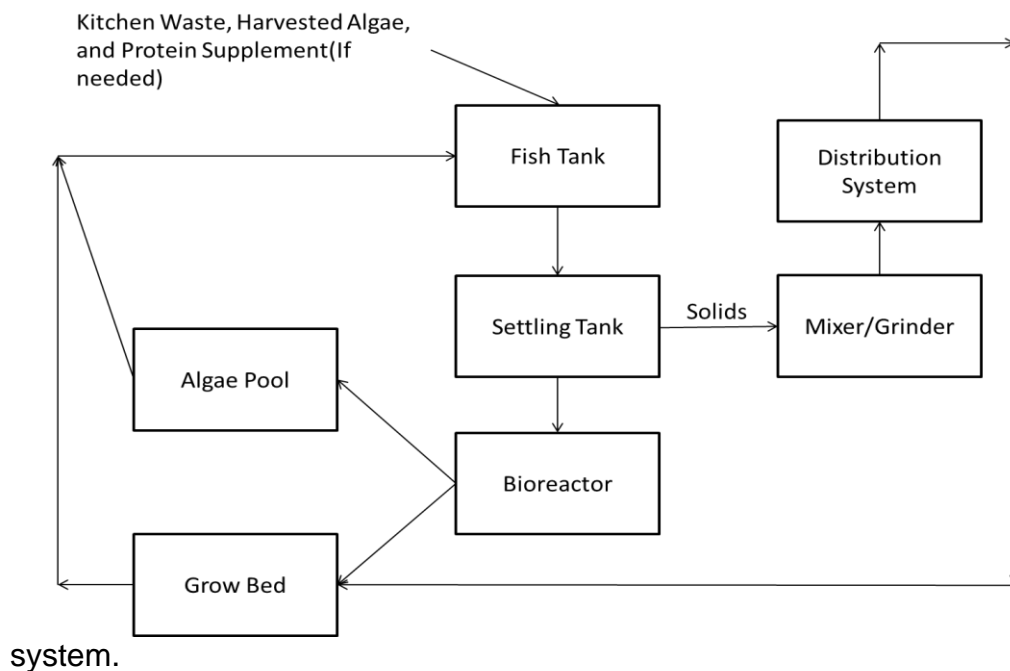

Figure 4: Block diagram for a closed-loop aquaponics system

Table 3 shows the values used for the calculation of the number of fish required for to produce the needed amount of ammonia to be fixed into nitrogen for plant growth. The mass of each fish varied based on the growth stage of the fish (Popma, 1995). The amount of ammonia produced by tilapia was dependent on the mass of food consumed. The number of fish required to produce enough ammonia to maintain plant growth was calculated assuming adult fish.

Table 3: Calculation Table for Production of Required Ammonia

Size of Fish	Weight of Fish (g)	in lb (W_f)	Ammonia Production (g/lb fish/day) or (F_{NH_3})	NH3 Required (g/day) or (T_{NH_3})
Fry	0.4	0.000882	0.1	125
Fingerling	50	0.110231	$N = \frac{T_{NH_3}}{F_{NH_3} * W_f}$	Least Number of Fish Required (N)
Juvenile	100	0.220462		834
Adult	680	1.499143		

8.2. Hydroponic

A hydroponic system uses water as the root matrix for plant growth. In this system plant roots are submerged in water supplemented with nutrients to encourage growth. Hydroponic systems are similar to aquaponic systems in terms of plant roots and growth. However, since nitrogen is not added by the fish, hydroponic systems require additional nutrient input into the water stream.

Figure 5 shows a typical hydroponic growth system.

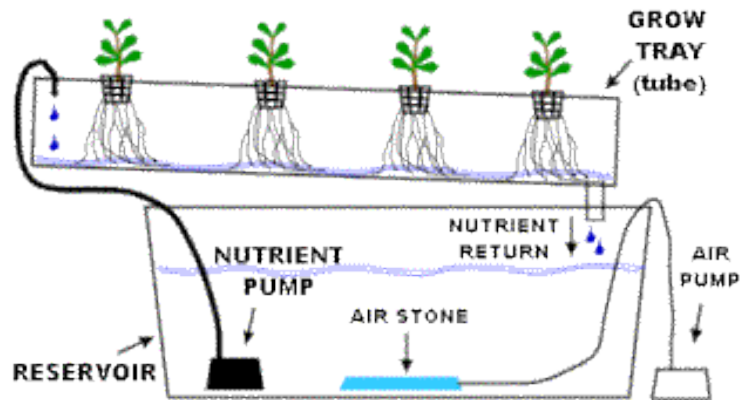

Figure 5: Typical hydroponic system set-up

8.3. Aeroponic

Aeroponic systems require the least water and nutrient input of any of the described systems. Plants are planted in a mesh sleeve and are sprayed with a nutrient solution multiple times a day. The roots are suspended in the air while the plant itself is suspended within the sleeve. It must be noted that any sustained power outage has the potential to kill the plants as the exposed roots will dry out. By removing root media, plant roots are directly exposed to the air which allows plants to have increased O_2 and CO_2 uptake rates. This results in increased growth rates while reducing the total weight of the system. The nutrient solution is sprayed from high pressure nozzles, requiring more robust piping and pumping systems. However, the overall benefits of the system include accelerated plant growth, reduced water and nutrient uptake, and versatile use.

The advantages and disadvantages of each system were discussed. The results of this discussion are shown in Table 4.

Table 4: Advantages and Disadvantages of Different Plant Growth Systems

Aquaponics	
Advantages	Disadvantages
1) Could be made into a closed loop system with little outside input. 2) Little growth Medium required	1) Requires large fish population to support plant growth 2) Requires large amount of water for system maintenance
Hydroponics	
Advantages	Disadvantages
1) Very little growth medium required 2) Cheaper than Aeroponics	1) Nutrients must be supplied to the system 2) Requires large amount of water for system maintenance
Aeroponics	
Advantages	Disadvantages
1) Efficient water usage. 2) No growth medium required. 3) Allows simple customization of nutrient delivery to each plant type	1) Higher operating pressure could cause leaks. 2) System failure must be corrected within 2 hours

9. Selection and Description of Design

9.1. Design Selection Justification

The initial design idea of using an aquaponic system was heavily encouraged during the SDR by NASA scientists and engineers due to its novel appeal. None of the NASA review group members had been exposed to the idea of using an aquaponic system. The unique aspect of the idea was being able to provide both meat as a dietary supplement and to use the fish to convert waste to usable nutrients for growing plants and algae. An aquaponic system would allow algae and the plants to consume the waste from the fish. Nonetheless, after analyzing the nutrient requirements of plants the steady state fish population to maintain plant growth was determined to be 567 kilograms of fish using Equation 1 and an input of ammonia calculated using an Excel workbook that calculated the daily nitrogen requirement at steady state to produce approximately 800 calories of food.

Equation 1:

$$N = \frac{T_{NH_3}}{F_{NH_3} * W_f}$$

Where:

- N = Number of fish needed
- T_{NH_3} = Total Ammonia needed (g/day)
- F_{NH_3} = Amount of Ammonia produced by fish (g/lb fish/day)
- W_f = Average weight of fish (lb).

While an aquaponic system can incorporate hydroponic and aeroponic systems, reducing the complexity of the system reduces the chances of system failure. An

aquaponic system was deemed impractical for a non-permanent establishment due to the large weight and area requirements for such a system.

An aeroponic system was deemed to be the best selection for the growing system within the greenhouse. The primary reasons for selecting aeroponics over hydroponic or conventional methods are reductions in water and nutrient usage and weight in addition to increases in plant growth rates and yields.

Aeroponic systems do not require a root media, but instead contain the base of the plant and roots within a mesh cup or envelope and allow the roots to hang below within the air. Furthermore, the length of the growing season per fruit is reduced, allowing for higher production rates. These rates are superior to all alternative methods and occur without a large increase in the complexity of the system. Thus, it was decided that an aeroponic system is the optimal choice for growing food on Mars for a short-term mission.

9.2. Aeroponic and Growing System

9.2.1. Aeroponic System

An aeroponic system can be constructed on both small and large scales.

Each system will have separate nutrient compositions to optimize growth.

Due to the large plant selection outlined below, multiple smaller systems with separate nutrient compositions will be required. For each given system, there are multiple system components required for pressure and stream regulation, plant support, and nutrient distribution.

T

The screenshot displays two main sections of the Smart Fertilizer GUI:

Tanks

Tanks Details

- Buttons: Auto Fill Tanks, Manual Fill Tanks
- Selected Fertilizers:

Calcium Nitrate	Used In Tank
Potassium Sulphate	Used In Tank
Magnesium Sulphate	Used In Tank
Mono potassium Phosphate (M.K.P)	Used In Tank
Fe-DTPA 11%	Used In Tank
- Parameters:

Number of Tanks	3
Water minimum temperature (°C)	5
Water with Fert. (m ³ /ha)	800.00
Estimated Irr. Water EC	2.87 <i>dy/m</i>

Tanks Distribution

Tank 1

Water	1000.00 (L)
Liquid Fertilizers	0.00 (L)
Tank Volume	1000.00 (L)

Fertilizer Name	Volume/M... Unit
Zn-EDTA 13%	0.53 Kg
Fe-DTPA 11%	1.02 Kg
Calcium Nitrate	48.39 Kg

Injection Ratio: 2.00 %

Tank 2

Water	1000.00 (L)
Liquid Fertilizers	0.00 (L)
Tank Volume	1000.00 (L)

Fertilizer Name	Volume/M... Unit
Mono potassium Phosphate (M.K.P)	4.73 Kg

Injection Ratio: 2.00 %

Tank 3

Water	1000.00 (L)
Liquid Fertilizers	0.00 (L)
Tank Volume	1000.00 (L)

Fertilizer Name	Volume/M... Unit
Magnesium Sulphate	22.51 Kg
Potassium Sulphate	30.45 Kg

Injection Ratio: 2.00 %

Buttons: Fertilizers, Save, Save and Print, Exit

Insert Target Values

Application Freq...: 180.00 days

Select Units: kg/ha

N Forms																	
Total N	N-NO3	N-NH4	N-NH2	P	K	Ca	Mg	S	B	Fe	Mn	Zn	Cu	Mo	Na	HCO3	Cl
120.00				17.02	230.71	158.54	38.02		0.300	2.000	0.800	0.350	0.040				

Crop Information

Name	Apricot
Variety	General
Plants/ha	0
Fert. Application Method	ByAreaMethod
Growing Method	General
Yield Goal	40.00 MT/ha
Stage / Recommendation	Total Nutrient Uptake

Buttons: Adjust by Soil/Tissue Test, Source Water

Figure 6: Smart Fertilizer GUI displaying the potential chemicals to create a nutrient solution and the nutrient data for a plant.

r

nutrient solution, individual plant needs must be met. Many commercial products currently exist that can easily be combined for individual plants. However, there is a possibility that these premixed solutions may not fully cover the range of nutrients required for all plants.

Nutrient solutions must be provided in at least two parts; one part containing anions and the other cations. If the nutrient solutions are not separated prior to mixing, there is a high chance that the contained elements and compounds will react and cause parts of the solution to precipitate, thus rendering some of the nutrients unavailable to plants due to the newly formed insoluble compounds. A selection of commercial premixed nutrient solution parts A & B exist on the market for hydroponic setups. To best optimize the fertilizers to be used within the mixing tank, commercial nutrient solution calculators exist. Figure 6 shows part of the GUI for Smart Fertilizer, a commercially available software package for creating fertilizer solutions for different crops at different stages in their life. Using this or similar software will ensure proper nutrient management for all plants. Furthermore, excessive salts and certain nutrients can harm plants. Electrical conductivity measurements can estimate the salt concentrations and are a viable means to monitor the quality of the nutrient solution.

To properly distribute water and nutrients to the plant roots, high-pressure nozzles are employed to distribute atomized water (10-50 μm droplets). Atomized water droplets have been found to significantly increase nutrient and water uptake rates when compared to larger droplets in previous studies. However, atomizing water droplets requires high pressure systems, ranging between 80 to 100 psi. While lower pressure aeroponic systems exist, they are unable to create atomized droplets. The primary challenge faced with this design choice is designing a high-pressure system, which

requires a more robust design that allows for fewer errors within the system and will be more likely to fail due to any breaches.

To effectively run a high-pressure aeroponic system, the piping system must maintain an elevated pressure for the entire duration of each watering period. A hydraulic accumulator will be used to maintain pressure in the lines, while a high-pressure water pump will be used to draw the nutrient solution from a non-pressurized reservoir and into the hydraulic accumulator. Using an accumulator ensures the high-pressure water pump does not need to run continuously to maintain pressure within the system. High-pressure tubing and piping will house the high-pressure nozzles and move nutrient solution to the plants.

Once the nutrient solution has been sprayed on the plant roots, a collection system is required to collect excess nutrient solution and return it to the nutrient solution reservoir. To reduce evaporation and maximize solution recollection while also reducing leaks, the sprayer nozzles and root systems will be contained within a water-tight system. This system will primarily employ gravity to drain water from the containers and into the nutrient solution reservoir.

To prevent foreign objects from entering the reservoir, in-line low-pressure filters will be installed between the collection system and the reservoir, and in-line high-pressure filters will be installed between the reservoir and the nozzles to prevent any nozzles from becoming clogged. A full schematic of the setup is shown in Figure 7.

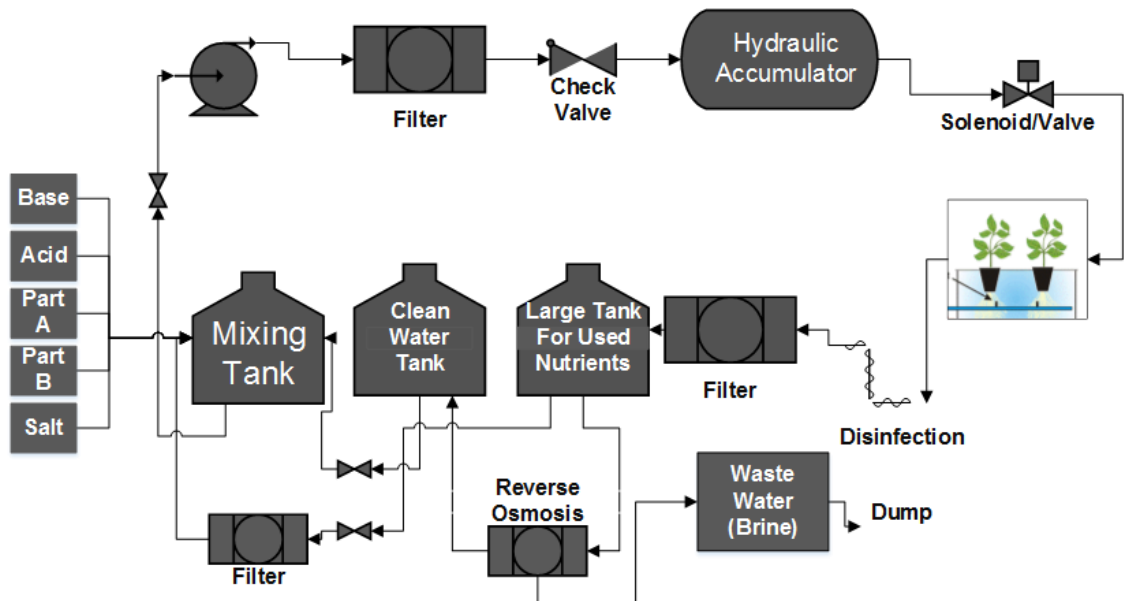

Figure 7: Overview of nutrient solution recirculation system.

A control system will be developed to properly pressurize and refill the accumulator with the nutrient solution. Solenoids will be used to turn the spray nozzles on and off according to a plant feeding schedule. Other necessary systems, such as returning the solution to the reservoir from the

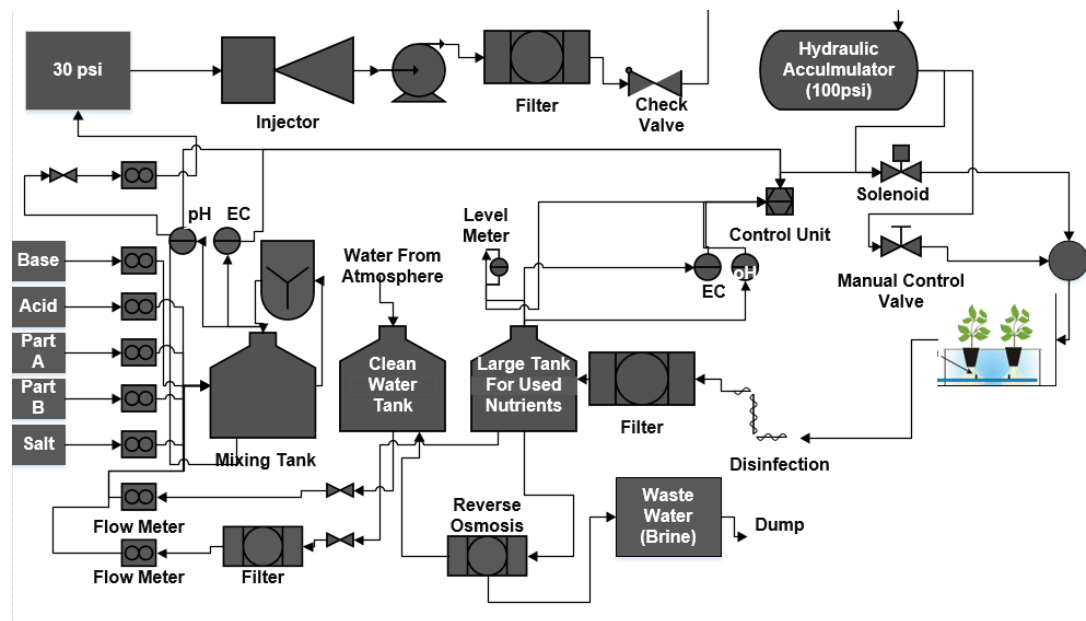

Figure 8: Overview of nutrient solution recirculation system and the associated instruments and controls.

collection system, will be added as the design progresses.

A schematic including some of the required aspects of the control system is shown in Figure 8. Furthermore, the quality of the nutrient solution (pH and total dissolved solids) will be constantly monitored to ensure the stability of the system, both from a nutrient and mechanical standpoint, as discussed earlier.

9.2.2. Germination

At this time, there are no selected germination procedures or equipment. Growth plugs, made of peat, rockwool, and other related materials can be used within the aeroponics bed to create a capsule of media allowing for germination. However, commercially produced germination beds exist and can be used for consistent germination results. Thus, it will be necessary to create proper germination procedures and select the most effective equipment.

9.2.3. Plant Selection

A wide selection of vegetables and fruits were first selected from a pool of plants that had previously been grown in aeroponic and hydroponic setups. From the pool of plants able to be grown in these systems, plants that are complimentary to one another when prepared for consumption were considered. Table 5 shows the crops that were considered for use in the GreenWings.

Table 5: Plants considered for use in the Green Wings

Leafy Greens	Lettuce, Spinach, Chard
Warm and Cool Season Vegetables	Broccoli, Cauliflower, Carrots, Green Onion, Cucumber, Radish, Snap Peas, Green Beans, Okra
Fruits/Berries	Tomatoes, Strawberries, Blackberries

9.2.4. Resource Viability Index

To assist with plant selection and prioritization, a rating system was created. Five plant characteristics were selected to make design selections: Plant yield, nutritional needs, daily water required, temperature range, and daily maintenance required. A graph was created for each plant that plotted the characteristics on the y-axis and the rating for each plant that ranged from 1 to 5 on the x-axis. A score of 1 is a poor rating, while a rating of 5 is high. A plant with all characteristics above 3 is considered ideal and therefore the plant with the most characteristics greater than 3 is considered the best option. This graphing method creates a visual representation of how close to ideal a given plant species is. Figures 9, 10, and 11 show the graphs created for each of the plant categories. Using the RVI score, the plants selected were lettuce, spinach, carrots, onions, cucumbers, radishes, snap peas, strawberries, and blackberries. Figure 12 shows the average RVI scores in each category for the selected plants.

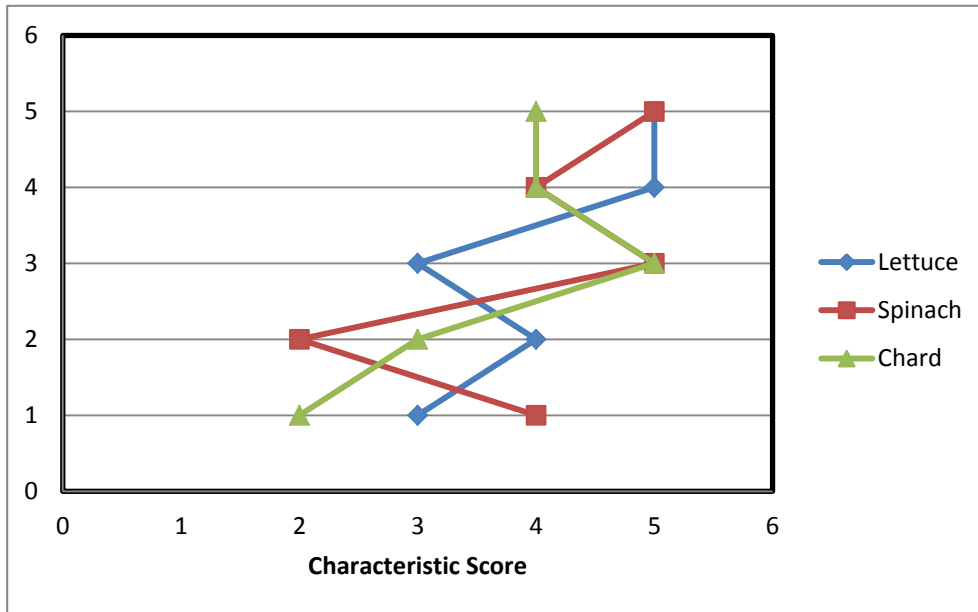

Figure 9: Shows the RVI for each of the leafy greens

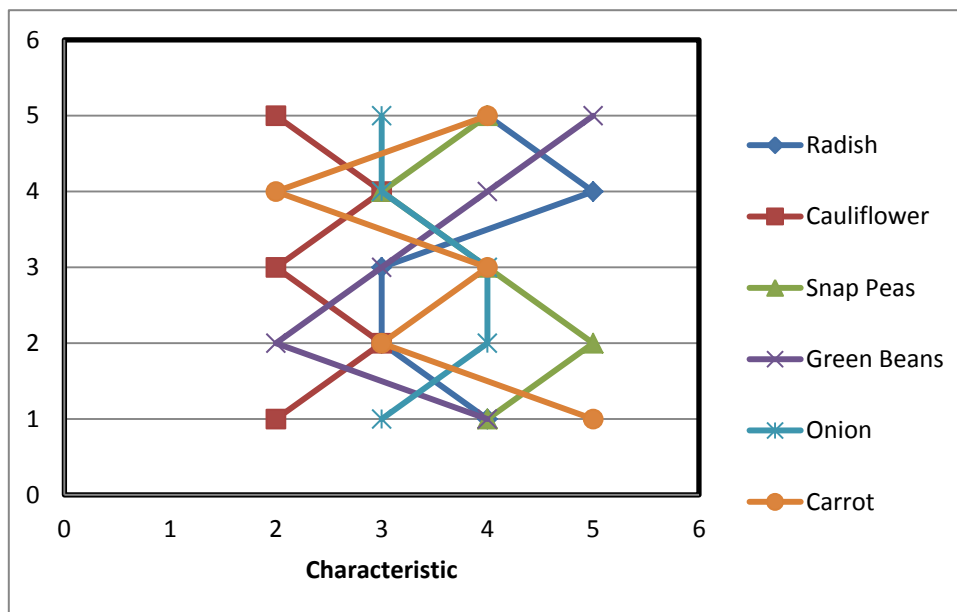

Figure 10: Shows the RVI for each of the considered cool season crop

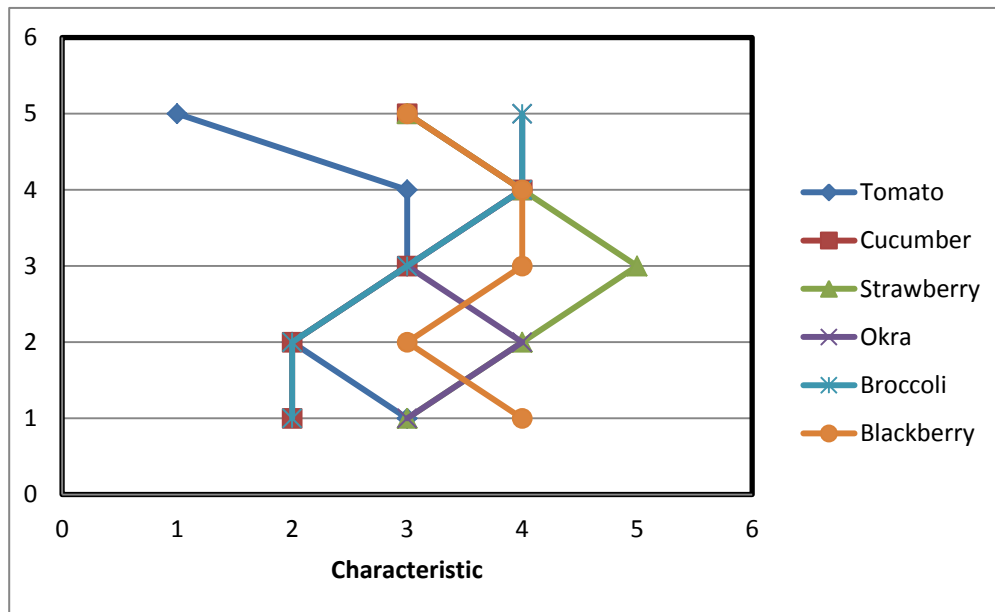

Figure 11: Shows the RVI for each of the warm season crops

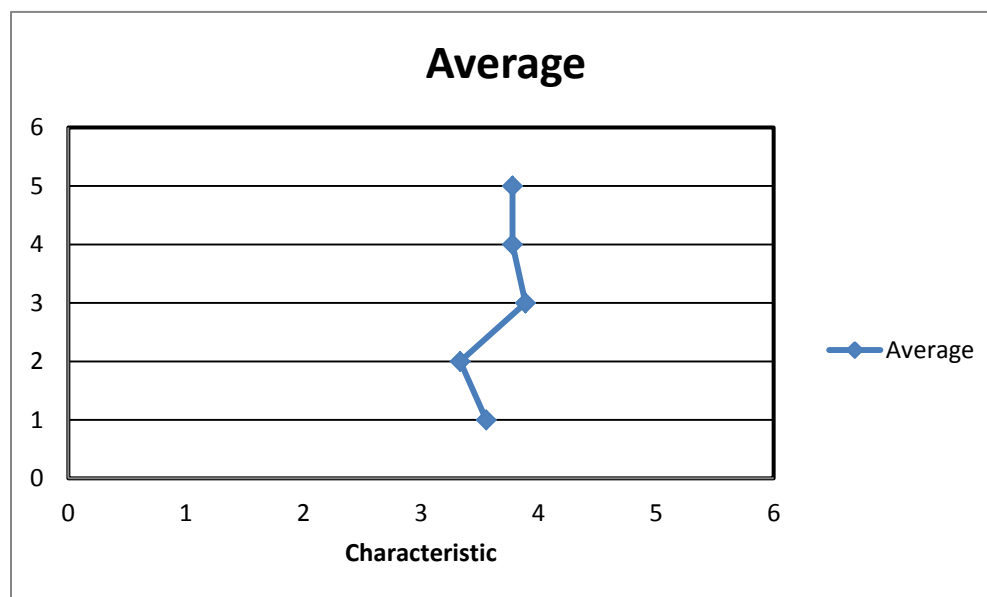

Figure 12: Shows the average RVI of each of the selected plant species

9.2.5. Plant Rotation

Plant rotations will be determined once a final selection of plants and a final GreenWing design as confirmed. Without knowing the available space, the proper density of certain plants cannot be determined. The plant rotation will

be selected primarily based on the environmental condition ranges required for the plants, thus allowing for up to four independent and different environments for the wide range of selected plants.

10. Risk Analysis

10.1. Analysis of potential issues in Aeroponics

10.1.1. Power Loss

In the event of power loss, there is a high chance that plants may not be able to survive for extended periods of time (greater than two hours). This is due to the pump and solenoid not functioning during loss of power.

10.1.2. Water Loss

Due to the fact that water is a precious resource, and in limited availability in the greenhouse, evaporation of water from plant roots can contribute to concentrations of salts and nutrients in the nutrient solution reaching levels lethal to plants.

10.1.3. High Pressure Lines

High pressure water lines will be more likely to expose any imperfections in the materials and assembly of the system. However, while any failures in the materials or assembly may cause the system to shut down in a limited capacity, none of the resulting leaks would result in highly dangerous situations for any astronauts present.

10.1.4. Germination and Crop Fatalities

There is a high chance that many plants will die during their life cycles. While this is expected for many plants that only produce one crop during

their lifetimes, many other plants producing multiple crops are not susceptible to disease.

10.2. Analysis of potential issues in automation

Automation will be implemented to keep the aeroponic system operating while astronauts are performing tasks away from the greenhouse. Such automation aspects include watering systems, lighting systems, and temperature regulation for the growing system. Many of the automation aspects will be developed by the BAE 3023 class with guidance from the Environmental Team. Automation systems must be energy efficient and reliable in high salinity conditions.

10.3. Analysis in potential issues of shelf deployment/maintenance

10.3.1. Deployment Failure

The structures and autonomous systems designed for deploying the greenhouse shelving could fail leading to non-deployment. In addition, the automated shelving or watering systems could malfunction post-deployment. This may lead to less research that can be conducted on Mars due to the researchers being used to repair the failed systems.

10.3.2. Material Failure

The material used for the systems and structures may be stressed during landing leading to a variety of problems ranging from shelving unit failure to partial or failed deployment of shelving units.

10.3.3. Limited resources for maintenance/repair

The material chosen for the shelving units may not be readily available on the Martian surface for repairs in case of shelving unit failure.

11. Risk Mitigation

11.1. Mitigation of Potential Aeroponics Issues

11.1.1. Power Loss

Power Loss to the aeroponics system is mitigated by having the roots contained within a system with minimal air movement which reduces water loss due to evapotranspiration around the roots. Nevertheless, further measures need to be considered. One such solution would be to employ manual controls on the accumulators to allow for the system to be run for a limited amount of time without power. Furthermore, hand-held sprayers could be used to distribute water onto the roots

11.1.2. Water Loss

In order to reduce potentially toxic nutrient concentration levels, reverse osmosis or distillation processes will be used to desalinate water. Water will also be recaptured from the GreenWing's atmosphere to help dilute these concentrations.

11.1.3. High Pressure Lines

To help mitigate issues with high pressure lines, regular inspection will be performed on the system. Any discovered issues would simply require the local system to be shut down temporarily while repairs are made.

11.1.4. Germination and Crop Fatalities

To prevent any food shortages due to fatalities, an excess of plant seeds required for initial crops will be taken on the mission since seeds are very light and compact. Additionally, in the case of pathogens causing the death of plants, sterilizing procedures will be developed to prevent the spread of pathogens to other plants. This will include the isolation and destruction of infected plants. All seeds and growing surfaces will be sterilized prior to deployment to prevent exposure to alien (coming from outside system) microbes, if they exist.

11.2. Mitigation of Potential Automation Issues

Automation system redundancy will be essential to prevent and detect failures in automation. Manual systems for deployment and operating the aeroponics system will be in place.

11.3. Mitigation of Issues with Shelf Deployment and Maintenance

11.3.1. Deployment Failure

In the event of a deployment failure, manual deployment features will be available to deploy the system.

11.3.2. Material Failure

In the event of a material failure, the system will be capable of isolating the failed material from the system. The GreenWing will also be designed with easy component replacement in mind in conjunction with the MAE team.

11.3.3. Limited Resources

Due the lack of resources and difficulty of repairs on the Martian surface, systems will be designed to be isolated in the event of a failure to allow for the system to be partially functioning until supplies can arrive.

12. Spring Semester

12.1. Nutrient and Water Mass Balance Modeling

A comprehensive model of the crops and their associated nutrients and water uptake will be developed using Simulink, a MATLAB-based software package. Within this simulation, the uptake and removal of nutrients, the water uptake, and the water recapturing mass balances will be not only mathematically but visually represented to better understand and present the system. This will allow for proper nutrient and water budgeting for the given system.

12.2. Analog Testing

Due to the complexity of this project, analog designs are being developed to test concepts and functionalities of individual systems of the deployable greenhouse. Many of these aspects cannot be tested with a full-scale model due to time constraints. One analog system that will be developed and tested jointly among the Environmental Team and the BAE 3023 class

is the deployment aspects of the aeroponics system. In addition, a GreenWing (deployable greenhouse module developed by the MAE team) analog prototype will be developed and tested at the Richmond Hill testing facility by a joint effort between the Environmental Team and the MAE team. Another analog system that must be developed is the aeroponics system. An aeroponic system will be assembled and tested to ensure concept functionality. This system testing will be functioning and growing plants by the end of January. This aeroponics system will be tested at the USDA-ARS hydraulics lab. Finally, the automation aspects of the aeroponics system (irrigation, nutrients, and lighting) will be tested by the end of April after they have been developed by the BAE 3023 class.

12.3. Nutrient Solution Correction

Working with Dr. Chad Penn in Plant and Soil Sciences, an automated nutrient solution creation, modification, and monitoring system will be developed. Using the pH as an indicator for the balance and the electrical conductivity as the measurement for concentration of the nutrient solution, dosing of additional chemicals to the nutrient solution will be calibrated using titration curves. Further, Dr. Penn will serve as a consultant for the necessary water test criteria and methods that will need to be conducted on a regular basis. With this knowledge, an automated system can be used to create and maintain the quality nutrient solutions needed by the plants for proper growth and production.

12.4. Other Plans

As analog systems are being developed and tested, there are other items that must be addressed as the semester progresses. The overall final design aspect must not be overlooked. A final aeroponics system for deploying into space will be developed with nutrient, lighting, plant, material, and other final specifications required for a successful Mars deployment. In addition, the Environmental and MAE teams will be working together to construct and test a GreenWing. Finally, the GreenWing and analog models will be presented and demonstrated on April 30, 2015 for the Biosystems Engineering senior design presentations and demonstrations.

12.5. Project Schedule

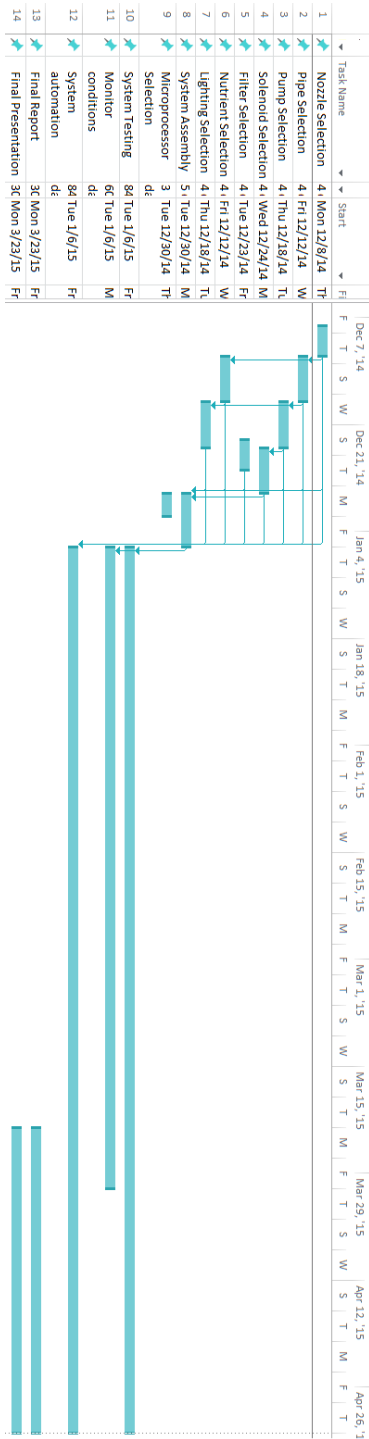

Figure 13: Gantt Chart

12.6. Work Breakdown Structure

12.6.1. Crop Rotation

Using design specifications for the GreenWing size from the structures group, a crop rotation will be selected that optimizes productivity and space. The crop rotation will ensure that there is fresh produce available throughout the operational period.

12.6.2. Nozzle Selection

The mister heads used to distribute the water onto the plant roots will be a critical aspect of ensuring proper nutrient delivery to the roots. The operating pressure of the mister needs to be between 70 psi and 100 psi.

12.6.3. Pump Selection

Pumps will be selected to apply the proper flow rate throughout the fully designed system at the gravity present on Mars. Pumps will also be selected to be light weight and low cost.

12.6.4. Filter Selection

A filtering system will be sized to the water load required by the crop rotation. This filtering system will be used to purify water with too high of an electro conductivity for continued use.

12.6.5. Nutrient Selection

A thorough investigation of commercial nutrient solutions will be performed. These solutions will be compared to the nutritional needs generated by the modeling program and optimized for weight and productivity.

12.6.6. Lighting Selection

In conjunction with the structures team, a lighting system will be selected and integrated into the deployable structure. This wavelength of the lighting system has been selected for optimal plant growth.

12.6.7. System Assembly

As part of the construction of an analog test system, a scaled-down aeroponic system will be constructed for testing. This system will include major aspects of the plant growth system. However, due to limited project scope, these simulations will not focus on the recycling of nutrient solution.

12.6.8. Microprocessor Selection

In conjunction with the Instrumentation and Controls class, microprocessors and sensors will be selected for the controls of solenoid valves in the nutrient distribution system. The bulk of the programming will be executed by the BAE 3023 members with the assistance of senior design team members.

12.6.9. System Automation

As part of the automation process, students from BAE 3023 will be working with the structures and environmental team to automate environmental controls, nutrient distribution, and system monitoring.

13. Project Budget

13.1. Cost Estimates

Table 6: Estimated Budget for Prototyping

Component	Price (\$)
20'-3" SCH 80 PVC	75.00
20'-2.5" SCH 40 PVC	63.40
20'-2" SCH 80 PVC	54.15
10'-1.5" SCH 80 PVC	\$19.94
20'-1" SCH 80 PVC	\$24.01
Water resistant fabric (2 yd)	32.00
spray jet for aeroponics	9.95/jet
3/8" tubing (100 ft)	19.55
Bladder Tank	152.50
PD piston pump (5.4 gpm)	200.00
Solenoid x 20	20
Nutrient Solution Mix	70.00
Total Price	To be determined

Table 7: Estimated Budget for NASA Mission

Component	Price (\$)
Weather resistant fabric (6 yds)	96.00
Sprayer jet for aeroponics	9.95/jet
3/8" Flexible tubing (100 ft)	19.55
Bladder Tank (2)	305.00
Solenoids x 20	20
Nutrient Solution Pump	200
Tank system for Algae	100.00
Total Price	To be determined

14. Environmental and Societal Impact

Most of the environmental impact will occur at or near the launch location due to exhaust and ignition fumes. Exhaust from rocket fuel will cause a temporary disruption in the air quality surrounding the launch site, while ignition will cause a temporary scorching of flora and fauna. After launch, jettisoned sections of the rocket will land in the ocean near the launch location. These sections will release small amounts of fuel and other contaminants into the water. Moreover, in the unfortunate event of an explosion, flying shrapnel may cause loss of life and property. If a small nuclear reactor (used as a power source for the greenhouse) is onboard during the explosion, radioactive fallout from the explosion may occur in the direction of the prevailing winds.

Assuming a successful mission, researchers on the Martian surface will be able to investigate the possibility of permanent human habitation on Mars. Overpopulation of areas on Earth such as prisons or urban areas may be relieved by transferring people to Mars. In addition, the ability to send humans to Mars may benefit life on Earth by advancing current Earth technologies. This is due to the advancement of technologies needed to successfully complete a mission to Mars. Finally, travel to Mars may become a formidable aspect of the tourism industry, resulting in financial gain for those who can provide travel to Mars and sustainable habitation once on Mars.

15. Design Summary

The use of an aeroponic system for growth within the NASA X-Hab Greenhouse structure will allow for increased yields with reduced water consumption over mission duration. The collapsible shelf design will provide a low weight, low volume solution to providing support structures for the aeroponic system. The creation of a resource viability index (RVI) allows mathematical design solutions to be applied in selection of plant rotation and quantity. As the preliminary design is transitioned to a final design, extra efforts will be made to create shelving that can be automatically deployed in conjunction with the deployment of the greenhouse. Design considerations will also be made to integrate the lines and fittings required for the aeroponic system into the inflatable deployment protocol. This will increase overall system automation as well as increase the technology readiness level (TRL) of the greenhouse.

16. Acknowledgements

The NASA X-Hab Environmental Team would like to thank Dr. Carol Jones for her assistance in developing the RVI graphs. We would also like to thank our BAE 1012 team, Nicholas Smith, Alex Ritchie, Chase Brum, Aaron Goodman, Meaghan Lackey, and Cale Williams for their research contribution to the aquaponics system. We would also like to thank Drs. Dunford, Vogel, and Storm for their permission to use their greenhouse at the USDA-ARS hydraulics lab. Furthermore, we would like to thank Drs. Long and Penn for their expertise.

17. References Consulted

Abdel-Fattah M. El-Sayed, N/A. Protein Nutrition of Farmed Tilapia: Searching for Unconventional Sources. Available at: <http://ag.arizona.edu/azaqua/ista/ista6/ista6web/pdf/364.pdf>. Accessed: 10/1/2014.

Adey, Walter H., and Purgason, 1998. Method of Raising Fish by Using Algal Turf. US 5778823 A.

Ako, H., Baker, A. 2009. Small-Scale Lettuce Production with Hydroponics or Aquaponics. College of Tropical Agriculture and Human Resources. SA-2.

Amirkolaie, Abdolsamad Keramat. 2005. Dietary Carbohydrate and Fecal Waste in the Nile Tilapia (*Oreochromis niloticus* L.). PhD diss. Wageningen, Gelderland: Wageningen University, Animal Sciences.

Barta, D. J., T. W. Tibbitts, R. J. Bula, and R. C. Morrow. 1992. Evaluation of light emitting diode characteristics for a space-based plant irradiation source. *Advanced Space Research*: Vol. 12 141-149.

Bluem, V., Paris, F. 2003. Possible application of aquatic Bioregenerative life support modules for food production in a Martian base. *Advanced Space* 31:77-86.

Brown, Christopher S., Andrew C. Schuerger, and John C. Sager. 1995. Growth and photomorphogenesis of pepper plants under red light-emitting diodes with supplemental blue or far-red lighting. *American Society of Horticultural Sciences*: 120(5):808-813.

Bula, R. J., R. C. Morrow, T. W. Tibbitts, D. J. Barta, R.W. Ignatius, and T. S. Martin. 1991. Light-emitting diodes as radiation source for plants. *Horticulture Science*: 26(2):203-205.

Cho, C., Bureau, D. 1998. Development of bioenergetics models and the Fish PrFEQ software to estimate production, feeding ration, and waste output in aquaculture. *Aquatic Living Resources*. 11: 199-210.

Delong, Dennis P., Losordo, Tomas M., and Rakocy, James E., 2009. Tank Culture of Tilapia. SRAC Publication No. 282. Southern Region Aquaculture Center.

Eding, E.H., Kamstra, A., Verreth, J.A.J., Huisman, E.A., and Klapwijk, A. 2002. Design and Operation of Nitrifying Trickling Filters in Recirculating Aquaculture: A Review. *Aquacultural Engineering* 34: 234-260.

Folta, K. M., L. L. Koss, R. McMorrow, H. Ki, J. D. Kenitz, R. Wheeler, and J. C. Sager. Design and fabrication of adjustable red-green-blue LED light arrays for plant research. 2005. *BMC Plant Biology*: 5(17).

- Graber, Andreas, and Ranka Junge. 2007. Aquaponics Systems: Nutrient recycling from fish wastewater by vegetable production. *Desalination*: 246 (2009) 147-156.
- Greinder, A. D., and Timmons, M. B. 1998. Trickle Filters in an Intensive Recirculating Tilapia Production Facility. *Aquacultural Engineering*. 18:189-200.
- Ho, L. C., R. I. Grange, and A. J. Picken. 1987. An analysis of the accumulation of water and dry matter in a tomato fruit. *Plant, Cell and Environment*: 10:157-162.
- Konig, A. N. M. 1990. Long-term temperature integration of tomato. Growth and development under alternating temperature regimes. *Scientia Horticulturae*: 25:117-127.
- Kumar, Ramasamy Rajesh, and Jae Young Cho. 2014. Reuse of hydroponic waste solution. *Environmental Science Pollution*: 21:9569-9577.
- Kunjapur, A. M. and R. B. Eldridge. 2010. Photobioreactor Design for Commercial Biofuel Production from Microalgae. *Ind. Eng. Chem. Res.* 49: 3516-3526. <http://www.che.utexas.edu/eldridge-group/pdf/Aditya.pdf>. Accessed 17 November 2014.
- Leatherbury, Megumi. Vegilab and aquaponics indoor growing system. 2014. Hawaii University International Conferences; Science, Technology, Engineering, Math, & Education. Honolulu, Hawaii.
- Lee, Choul-Gyun, and Palsson, Bernhard O., 1994. High-Density Algal Photobioreactors Using Light-Emitting Diodes. *Biotechnology and Bioengineering*. Vol. 44: 1161-1167.
- Lennard. W., Leonard, B. 2006. A comparison of three different hydroponic sub-systems (gravel bed, floating and nutrient film technique) in a Aquaponic test system. *Aquaculture International*. 14:539-550.
- Maathuis, Frans J.M. 2013. *Plant Mineral Nutrients Methods and Protocols*. York, UK: Springer Science.
- Mackowiak, C. L., G. W. Stutte, J. L. Garland, B. W. Finger, and L. M. Ruffe. 1997. Hydroponic potato production on nutrients derived from anaerobically-processed potato plant residues. *Advanced Space Research*: Vol. 20 No. 10:2017-2022.
- Mackowiak, C. L., R. M. Wheller, G. W. Stutte, N. C. Yorio, and J. C. Sager. 1997. Use of biologically reclaimed minerals for continuous hydroponic potato production in a CELSS. *Advanced Space Research*: Vol. 20 No. 10:1815-1820.
- Mackowiak, C.L., J.L. Garland, R.F. Strayter, B.W. Finger, and R. M. Wheller. 1996. Comparison of aerobically-treated and untreated crop residue as a source of recycled nutrients in a recirculating hydroponic system. *Advanced Space Research*.: Vol 18. 281-287.
- Massa, Gioia D., Hyeon-Hye Kim, Raymond M. Wheeler, and Cary A. Mitchell. 2008. Plant Productivity in Response to LED Lighting. *HortScience*: 43(7).

Massa, Gioia D., Jeffrey C. Emmerich, Robert C. Morrow, C. Miuke Bourget, and Cary A. Mitchell. 2006. Plant-growth lighting for space life support: a review. *Graviational and Space Biology*: 19(2).

Mississippi State University. 2014. Tilapia Stocking Rate in Mississippi. Mississippi State University Extension Service. Available at: MSUcares.com/aquaculture/tilapia/stocking.htm. Accessed: 29 November 2014.

Mjoun, Kamal, Rosentrator, Kurt A., and Brown, Michael L. 2010. TILAPIA: Environmental Biology and Nutritional Requirements. South Dakota Cooperative Extension Service. FS963-02:1-7.

Muller, M.S., and Bauer, C.F., 1996. Oxygen Consumption of Tilapia and Preliminary Mass Flows through a Prototype Closed Aquaculture System. NASA-TM-111882: 1-17.

NASA. Advanced Space Transportation Program: Paving the Highway to Space. National Aeronautics and Space Administration. Available at: <http://www.nasa.gov/centers/marshall/news/background/facts/astp.html>. Accessed 17 November 2014.

Nelson, R. L., and Pade, J. S. 2007. Auaponic Equipment: The Clarifier. *Aquaponics Journal Issue 47*: 30-31.

Nir, I. 1982. GROWING PLANTS IN AEROPONICS GROWTH SYSTEM. *Acta Hort. (ISHS)* 126:435-448 http://www.actahort.org/books/126/126_49.htm. Accessed 17 November 2014.

Ono, Eiichi. 2001. Monitoring of nutrient solution for hydroponically grown sweetpotato (*ipomoea batatas*). PhD Dissertation. Tucson, AZ: The University of Arizona.

Peterson, L. A and A. R. Krueger. 1988. An Intermittent Aeroponics System. *Crop Science*. 28(4): 712-713. doi: 10.2135/cropsci1988.0011183X002800040033x.

Popma, Thomas J. and Lovshin, Leonard L. 1995. Worldwide Prospects for Commercial Production of Tilapia. International Center for Aquaculture and Aquatic Environments Department of Fisheries and Allied Aquaculture: 12-19

Rakocy, James E. 1989. Tank Culture of Tilapia. Southern Regional Aquacultural Center. Pub. No. 282(3).

Rosen, Carl J., and Roger Eliason. 2005. Nutrient management for commercial fruit & vegetable crops in Minnesota. University of Minnesota Department of Soil, Water, and Climate; University of Minnesota Extension Service; USA-Risk Management Agency.

Shalhevent, J., and B. Yaron. 1973. Effect of soil and water salinity on tomato growth. *Plant and Soil*: 39:285-292.

Shimokawa, Akihiro, Yuki Tonooka, and Misato Matsumoto. 2014. Effect of alternating red and blue light irradiation generated by light emitting diodes on the growth of leaf lettuce. bioRxiv. Available at: <http://dx.doi.org/10.1101/003103>. Accessed 1 October 2014.

Shnel, N., Barak, Y., Ezer, T., Dafni, Z., and Rijn, J.V. 2006. Design and Performance of a zero-discharge Tilapia Recirculating System. *Aquacultural Engineering* 26: 191-203.

Siddiqui, A., Al-Harbi, A. 1999. Nutrient budgets in tanks with different stocking densities of hybrid tilapia. *Aquaculture* 170: 245-252.

Sikawa, D. Yakupitiyage, A. 2010. The hydroponic production of lettuce by using hybrid catfish pond water: Potentials and constraints. *Agricultural Water Management*. Vol 97: 1317-1325.

Timmons, M. B., Summerfelt, S. T., Vinci, B. J. 1998. Review of Circular Tank Technology and Management. *Aquaculture Engineering* 18: 51-69.

Tokuyama, T., Mine, A., Kamiyama, K., Yabe, R., Satoh, K., Matsumoto, H., Takahashi, R., Itonaga, K. 2004. *Nitrosomonas communis* Strain YNSRA, an ammonia oxidizing bacterium, isolated from the reed rhizoplane in an aquaponics plant. *Bioscience and Bioengineering*. 98:309-312.

Wheeler, R. 2003. Carbon balance in Bioregenerative life support systems. *Advanced space* 31: 169-175.

Wheeler, Raymond M. 2010. Plants for human life support in space: from Myers to Mars. *Gravitational and Space Biology*: 23 (2).

Xiu-fen, Z. H. A. O. (2009). Study on Application of Algae Fertilizer on Vegetable Production [J]. *Journal of Anhui Agricultural Sciences*, 6, 115.

Yorio, Neil. C., Gregory D. Goins, Hollie R. Kagie, Raymond M. Wheeler, and John C. Sager. 2001. Improving spinach, radish, and lettuce growth under red light-emitting diodes (LEDs) with blue light supplementation. *HorticScience*: 36(2):380-383.

18. Appendices

18.1. Notes from PDR

Tracy Gill-

- HDU
 - No weight optimization by NASA
 - All weights are from analog
 - Need to optimize for flight design

Morgan Simpson-

- What does greenwing analog look like?
 - Answer
 - Check to see if it inflates properly
 - Pack properly
 - Test aeroponics system
 - Automate as many things as possible

Ray Wheeler

- Liked the modular concept- ability to grow in the future
- LEDs- prudent
- Aeroponics vs. recirculating hydroponics
 - Would aeroponics actually use less water?
 - Water use and nutrient use are probably close to the same for each
- Failure and risk analysis
 - Pump failures
 - Need to respond quickly for plants to survive
 - How would we prevent wilting
 - Cool temperature
 - Turn lights off
 - Could use ponded water (if roots reach water)

Gioia Massa

- Likes design- potential
- Is everything an opaque structure?
- Thermal qualities of chosen materials?
 - Answer
 - Kevlar and Kapton
 - Gases
 - Replenish CO₂
 - O₂ level management
 - Answer = airlock
 - Central hub has control
 - Each greenwing can have different atmospheric conditions

- Gases can be routed from wing to wing
 - Consider compressed gases
 - Feed back in when needed
 - Younger plants will not be producing as much O₂
 - Balance by rotating plants
 - Stagnation of air occurs in large commercial greenhouses
 - Consider fans to move air
- Shape and organization of lights
 - Pack them in?
 - Strip lights
 - Instead of changing lighting configuration, could change plant location

Headhouse Section

- Use for “dirty” operations
- Layout and materials handling

Mass

- Look at ISS masses for a flight mass baseline
 - MPLM
 - Look at modules with similar number of parts
 - Scale up ISS modules since they are not 5m in diameter

Gioia Massa

- Humidity control from plants
- Condensing surfaces
 - Where would we put them
 - What type of surfaces
- Could use Mars to help with thermal gradient
- Could use condensation as potable water

Charlie

- Need to protect structure
 - Radiation
 - Particles from arriving vehicles
 - Kevlar as skin protection- how does this work with radiation
 - Need to do more research

Additive Manufacturing

- 3D printed regolith for printing
- Currently printing test coupons on ISS with 3D printer
- Even if tech is only emerging, do not discount its use in the future

Compile a list of assumptions

- Answer
 - We are not considering unlimited resources
 - Assuming landing vehicle

For CDR

- Provide organizational/structural diagram
- Show presenters picture when they are talking

Dr. O'Hara

- Consider having inflatable greenwing structure hoops- easy to store
- Telescopic greenwing floor
- Can we fit all greenhouse systems in one flight

Dr. Wang

- What are we going to do with diseased plants?
 - Can sterilize system
 - Moisture will produce mold
 - Look at cleaning process/solution
 - No biofilms

18.2. Notes from SDR

Team's Question	NASA's Answer
Target crew size?	<ul style="list-style-type: none"> • Up to team • 4 to 6
Mission duration?	<ul style="list-style-type: none"> • Not fully defined by NASA • 6 months, 1 year, 500 days • Up to team (within reasonability)
Should crops grown be supplementary to diet or comprise the whole diet?	<ul style="list-style-type: none"> • Evolutionary approach: start as supplemental and move to whole diet • Concentrate on near time
Any particular crops you DO or DO NOT want?	<ul style="list-style-type: none"> • Concentrate on near time • Salad crops • Minimal processing crops (potatoes) • Wheat, soybeans, etc. need additional infrastructure • Eaten fresh and minimal processing, cooking capabilities • Literature can/will be provided
Dimension restrictions?	<ul style="list-style-type: none"> •
Bring Earth soil or use Martian?	<ul style="list-style-type: none"> • Consider hydroponics (need to bring water regardless of growth media) • Soil testing may be out of schedule range • Dr. Jacob article- http://io9.com/new-evidence-that-we-could-grow-vegetables-on-mars-and-1636418166
Any preferable location?	<ul style="list-style-type: none"> • Low latitudes get the best sun • Radiation function of altitude-lower=better
Types of primary/secondary energy sources for greenhouse?	<ul style="list-style-type: none"> •
Potential complications with attempting to harvest nutrients/air from Mars?	<ul style="list-style-type: none"> • Literature can/will be provided
Potential for aquaculture?	<ul style="list-style-type: none"> • Interesting idea worth further investigation

Comments from NASA:

- Look for ways to scale back project to stay on schedule and budget
 - Composting and soil testing may take too long
- NASA estimates per person
 - 40-50 m²
 - 2,500 Cal/day
- Plants require 1/3 to ¼ atm
 - O₂ partial pressure = 10-15 kPa
- Okstate Mockup
 - Full/final not a totally closed system for safety reasons
 - Smaller closed system test
- Possible buried structure?
 - Penny Boston
 - Lava tubes
 - Protects against environment (dust, wind, etc.)
 - <http://www.space.com/18546-mars-caves-sample-return-mission.html>
 - <http://www.spacedaily.com/news/mars-life-04w.html>
- Light
 - Not UV
 - Usually use red/blue LEDs
 - Fiber optic?
- Must recycle ET
- Water from Mars

Schedule/Future Presentation Comments:

- Flexible on dates
- Do not have to review topics from previous presentations
- Final report: Can be in whatever form/format Okstate requires
- Possible communication with other X-Hab teams?
- Give monthly/bi-weekly updates to NASA contacts
- Cc Kelsey, Jessica, Dr. Jacob if communicating with NASA contacts

Future Questions:

1. Food storage?
2. Dimension restrictions? SLS?
 - a. Dimensions of module?
 - b. Mass?
 - c. Volume?
3. Types of primary/secondary energy sources for greenhouse?
4. Water in soil?
5. Major obstacles/questions encountered by contacts in their research?
 - a. What do they specifically want us to consider/think about? What is important to them in terms of design?

NASA X-HAB

Environmental Design Team

12/04/2014

J.C. Overton M.B. Rogers
P.Q. Storm B.Z. Bennett

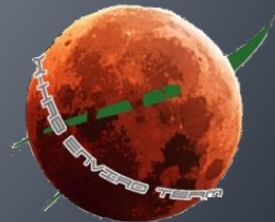

Overview

- Mission and Problem Statement
- Literature Review
- Preliminary Design Concepts
- Secondary Design Concepts
- System Design
- Risk Analysis
- Project Budget
- Project Schedule
- Spring Semester

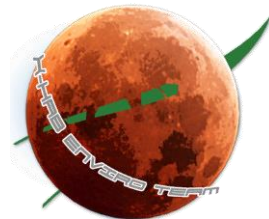

Mission Statement

- Develop fully autonomous greenhouse systems enabling human exploration on the Martian surface
- Develop, integrate, test, and evaluate greenhouse systems that will be utilized as technology test bed and to advance NASA's understanding of alternative mission architectures, requirements, and operations concepts definition, and validation

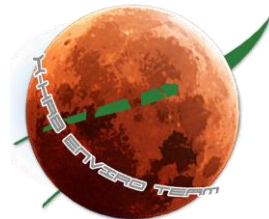

Problem Definition

- Provide dietary supplementation to a four-person crew on the Moon or Mars
- Self-sustaining, collapsible, and lightweight design
- Automated control systems must be used where possible to reduce man hours required for operation

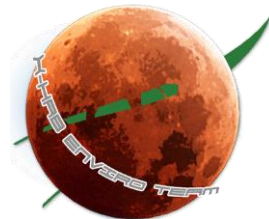

Customer Requirements

- Provide supplemental diet for crew of four (4) for up to 500 days
- Infrastructure Assembly
 - Must be deployable in conjunction with deployment of GreenWings
- Area
 - NASA requires the total structure to be less than 75 m² per person (300 m² total)

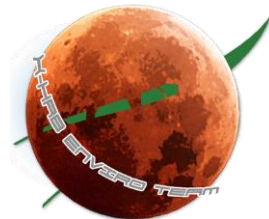

Design Criteria

- Growing System
 - Need to minimize space, maximize efficiency, and make adaptable
 - Independent nutrient/watering regime for each plant type
- Provide a balanced supplemental diet for crew
- Plants should be selected for both hydroponic growing capabilities and low maintenance requirements
 - Leafy greens, warm and cold season vegetables, and berries are possibilities

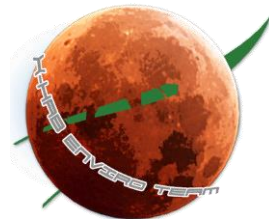

Structures

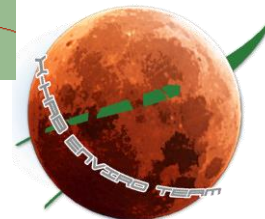
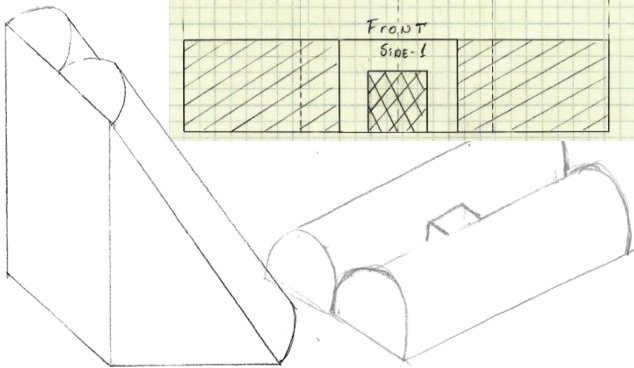
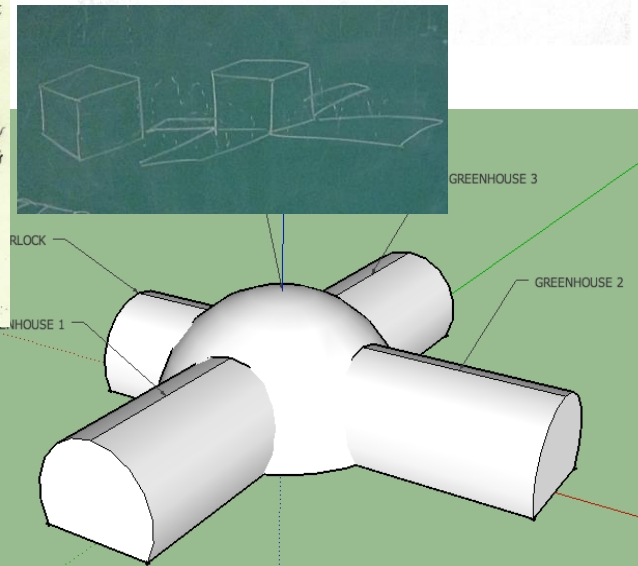
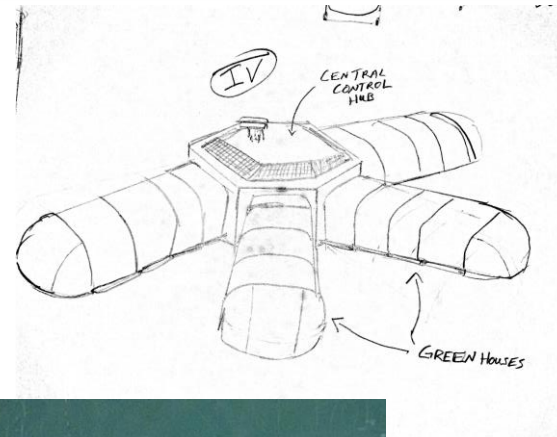
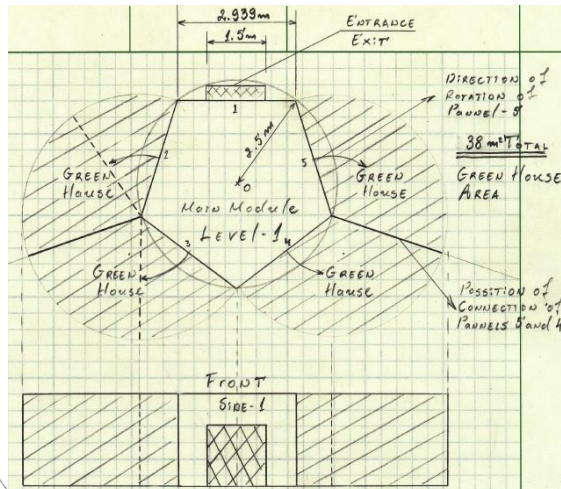

Structures

- There will be four (4) wings (GreenWings) centered at a main hub
 - Each GreenWing can have a customized environment for different crop requirements

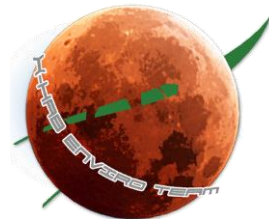

Structures

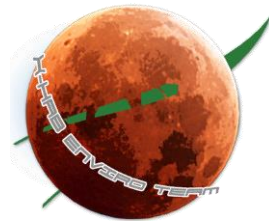
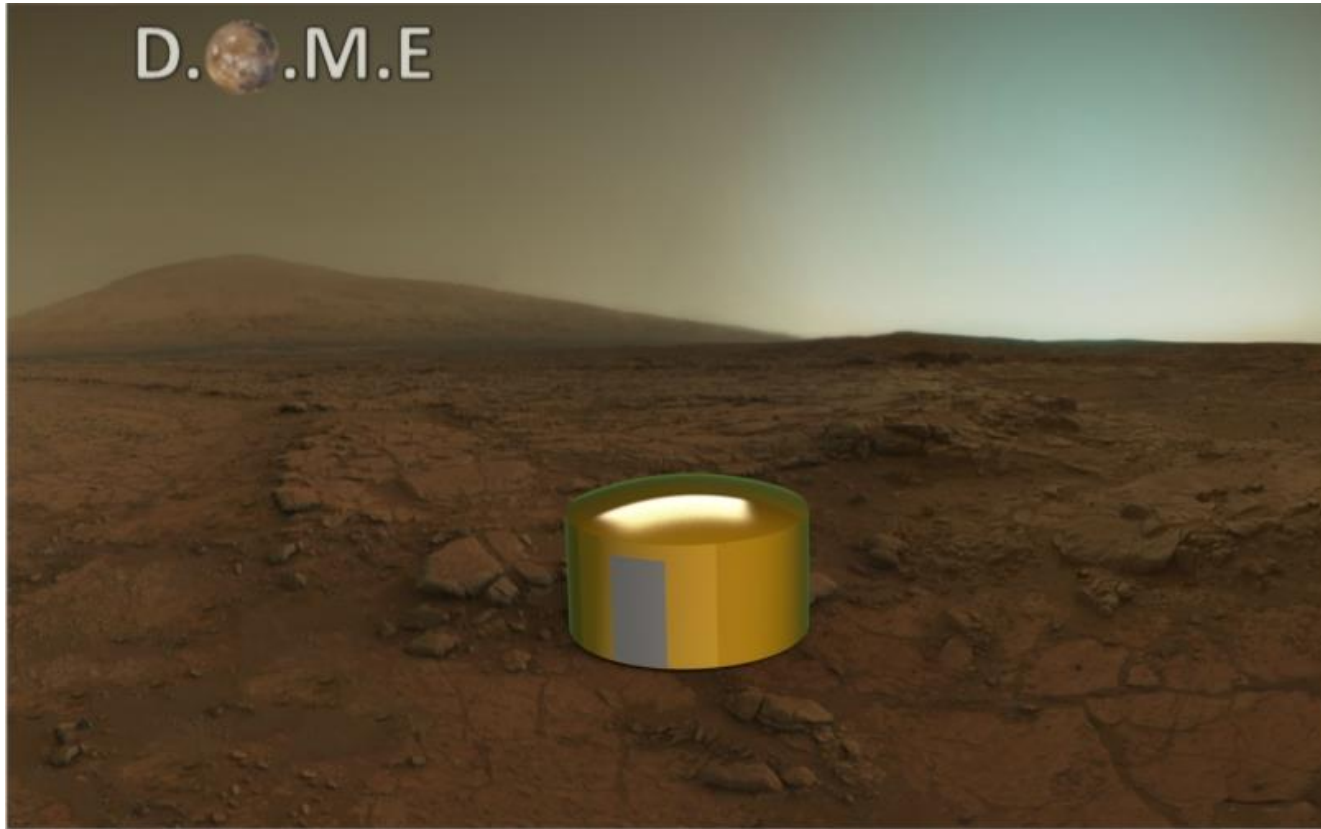

Structures

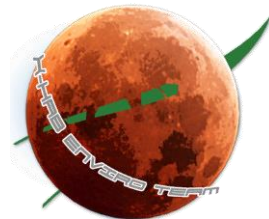
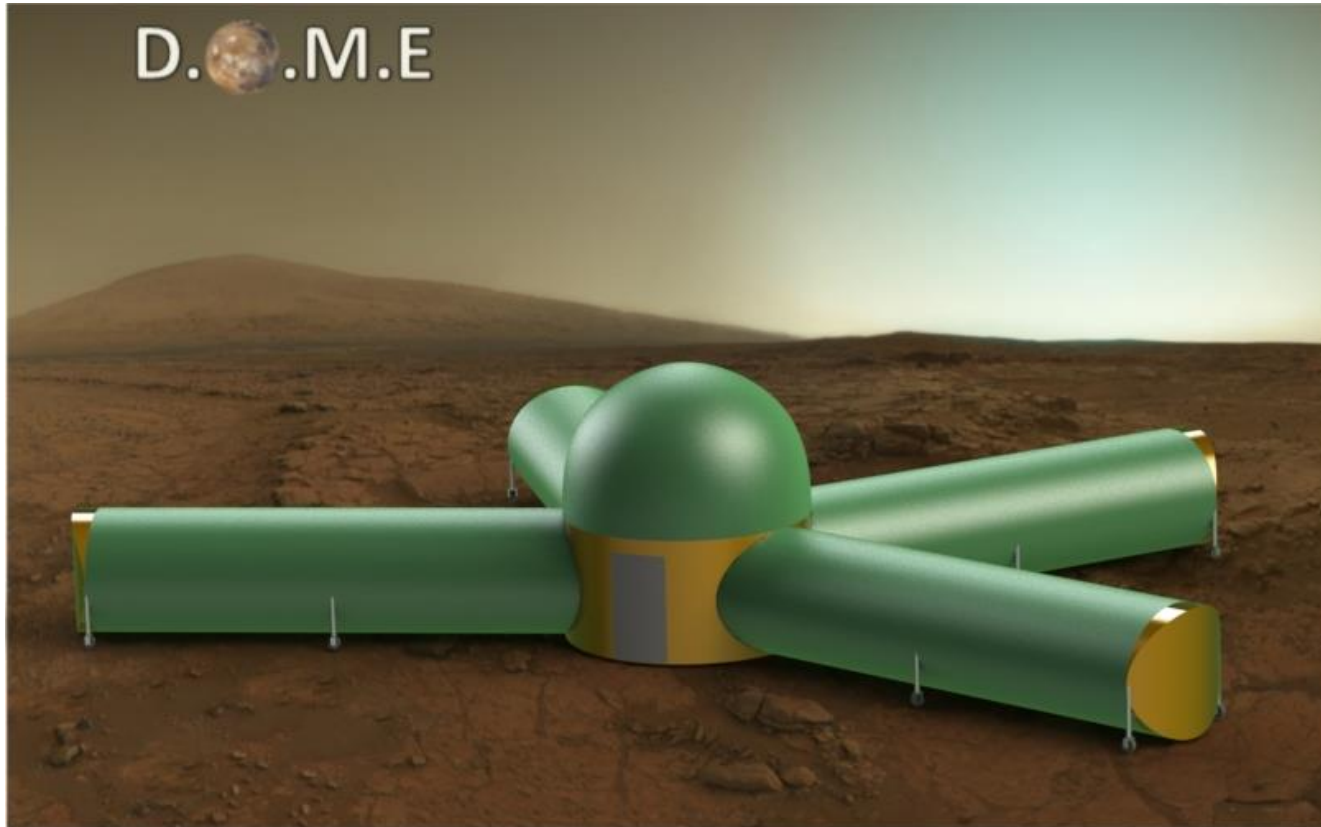

Deployment

- The structures team has selected an inflatable deployment system

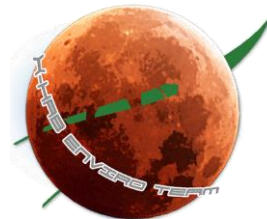
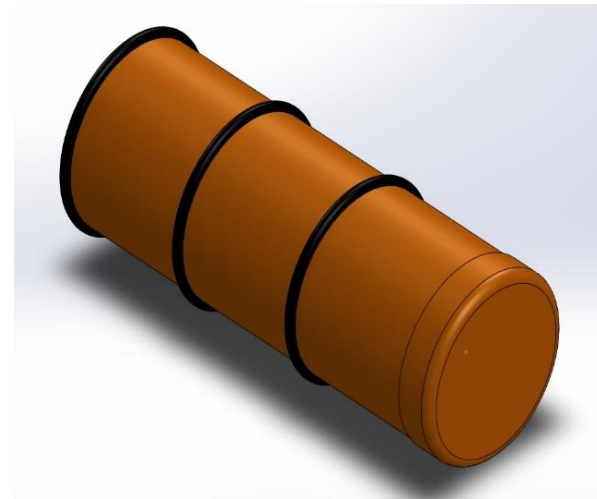
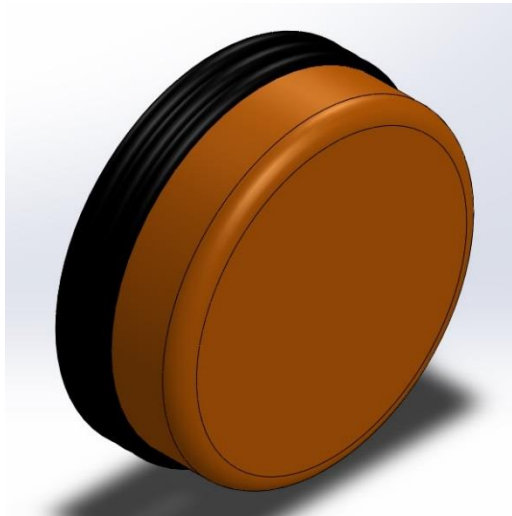

Design Concepts

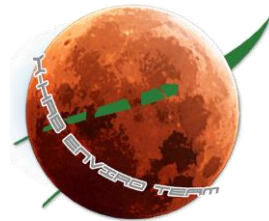

Preliminary Design Concept

■ Aquaponics

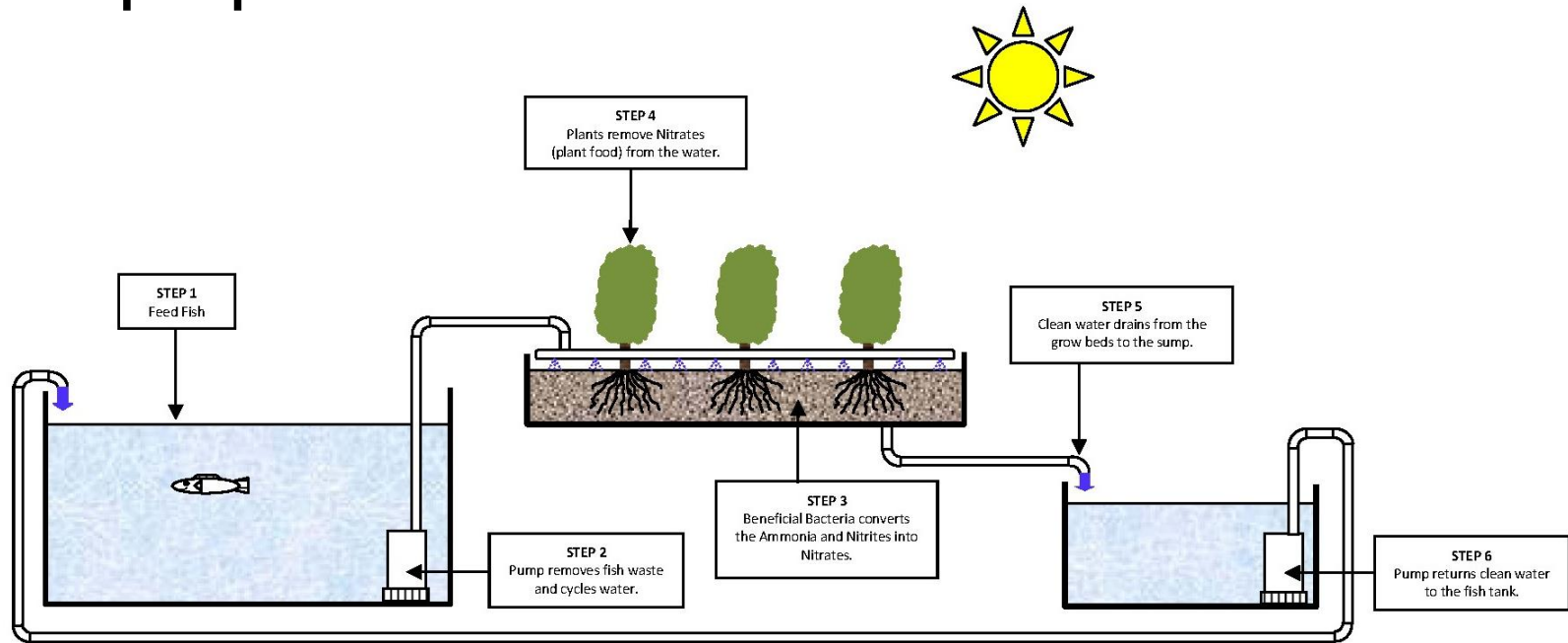

Aquaponicshowto.com

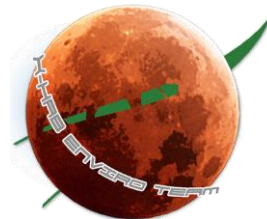

Preliminary Design Concept

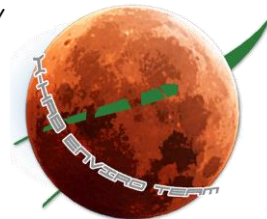
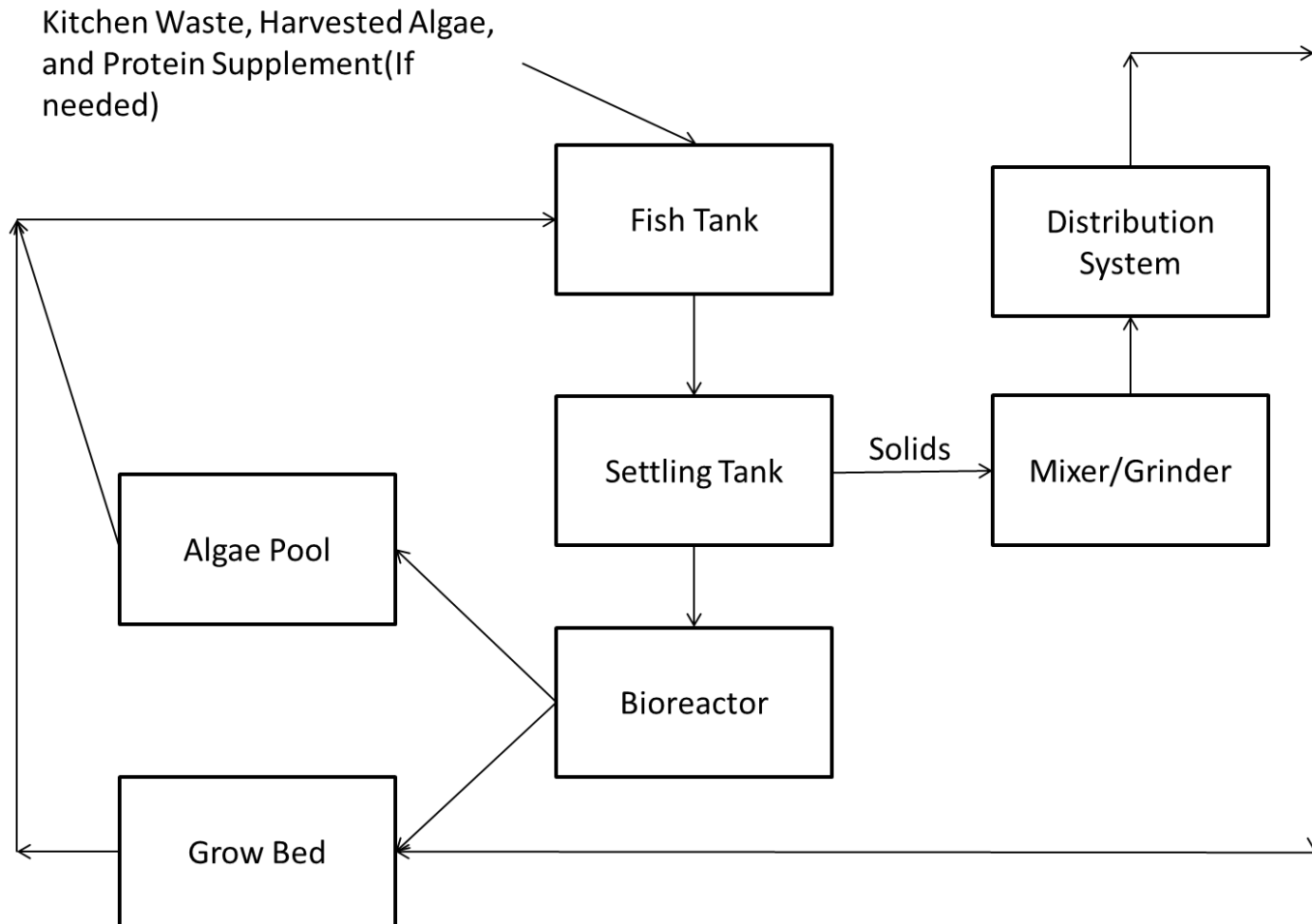

Preliminary Design Concept

- Estimation of Nitrogen Requirement
 - Assumed Production of 800 calories/day
 - Number of plants determined by crop rotation
 - N/day calculated at steady state
 - N/day estimated to be 125 g/day using Excel

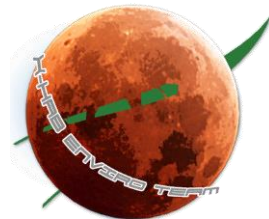

Preliminary Design Concept

- $$N = \frac{T_{NH_3}}{F_{NH_3} * W_f}$$

- Where:

- N = Number of fish needed
- T_{NH_3} = Total Ammonia needed (g/day)
- F_{NH_3} = Amount of Ammonia produced by fish (g/lb. fish/day)
- W_f = Average weight of fish (lb.).

- N = 834 Fish at 1.5lb each.

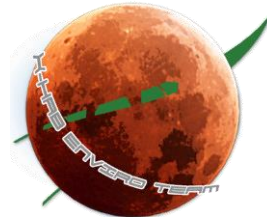

Preliminary Design Concept

- Original NASA interest had been in novelty of aquaponic design
- Assuming a cost of \$10,000/lb. to get items into space, the cost of getting the fish just into orbit would be \$12.5 million
- Not feasible due to transport logistics, large fish population, and cost restrictions

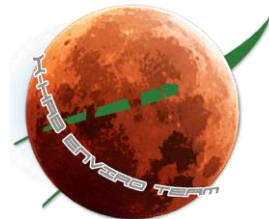

Secondary Design Concepts

- Hydroponic Growing System
 - Low line pressure
 - Requires constant maintenance of water conditions

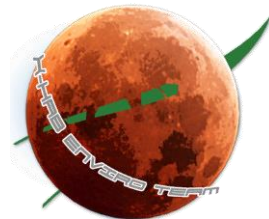

Hydroponic Growing System

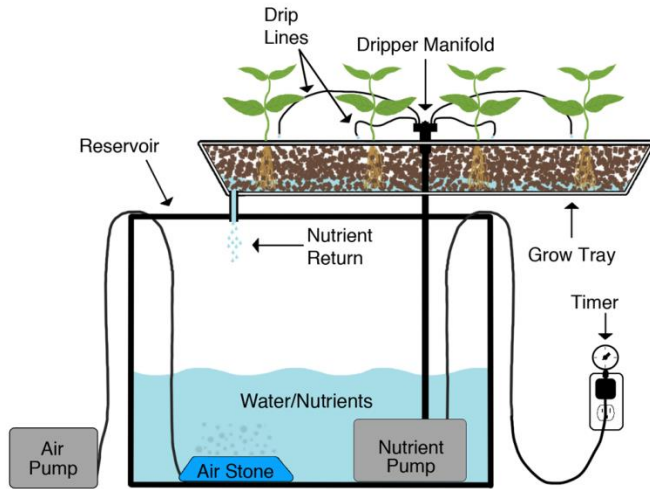

greendesert.org

Drip System

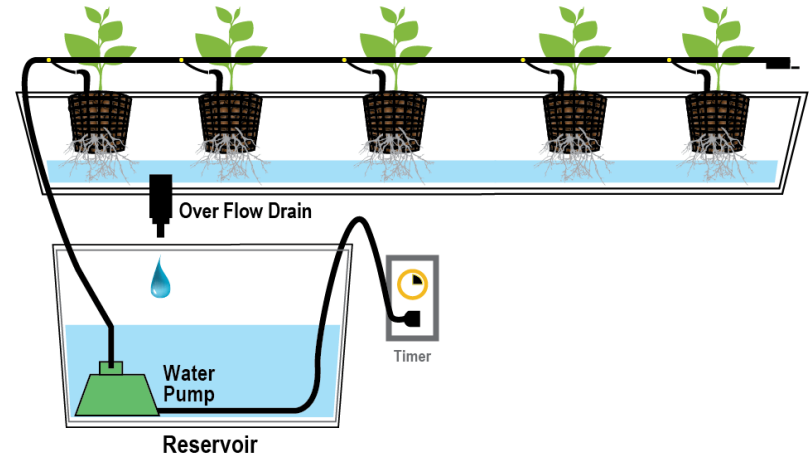

Sdhydroponics.com

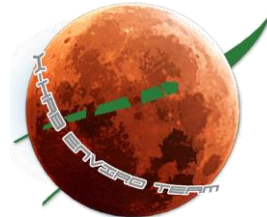

Secondary Design Concepts

- **Aeroponic Growing System**
 - Low nutrient consumption
 - Uses non-organic nutrient supplements
 - Increases gas transfer at roots
 - Results in higher productivity
 - Requires high pressure for 10-50 μm droplets
 - Higher risk of plant death with power loss

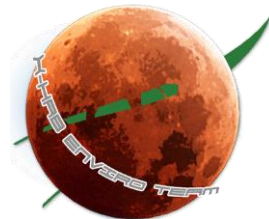

Aeroponic Growth System

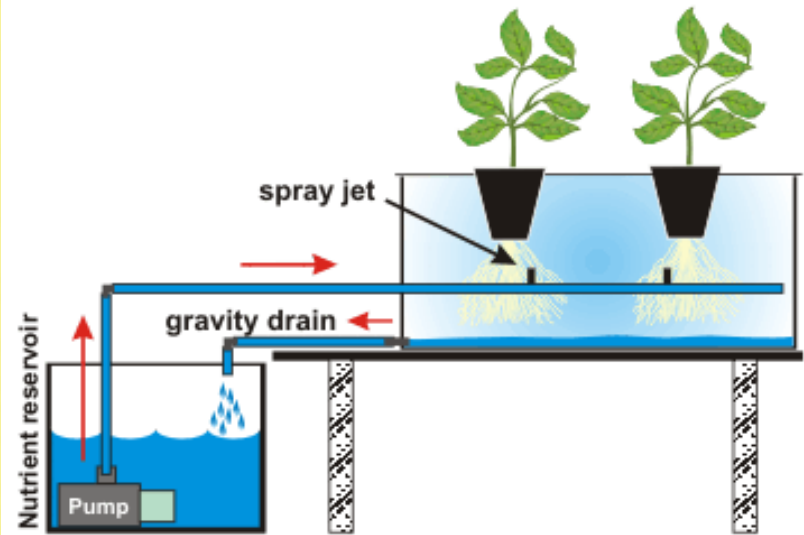
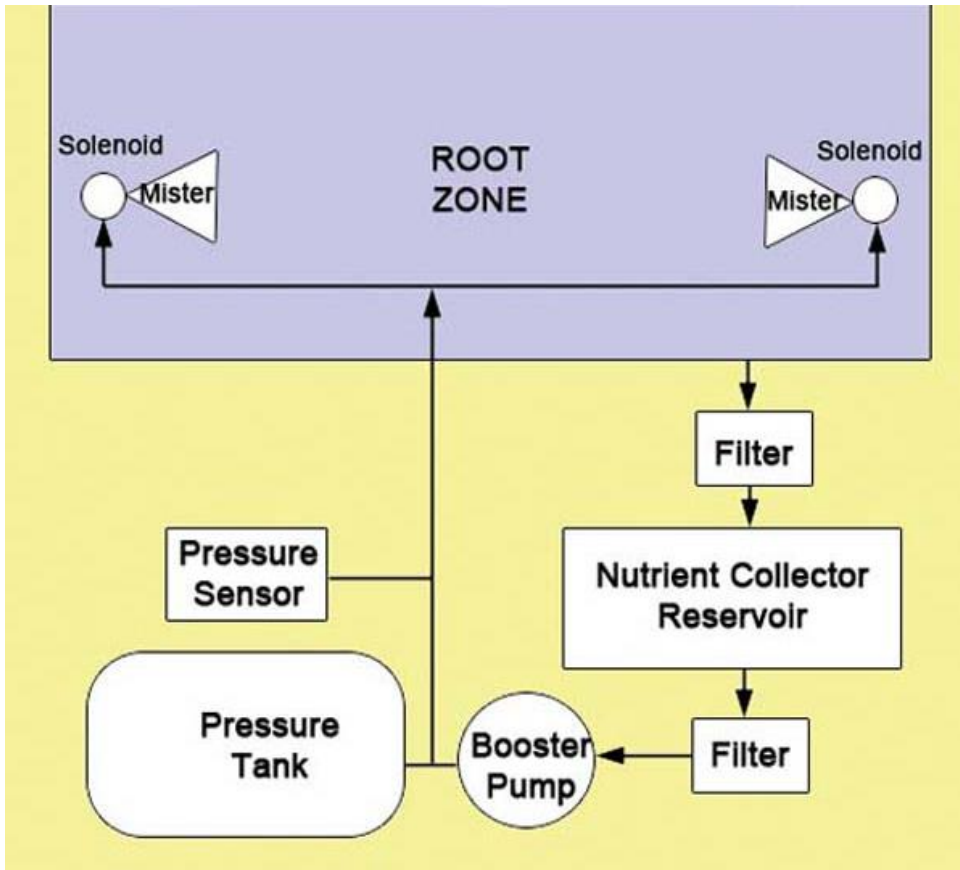

http://www.flairform.com/hints/aeroponic_system_popup.gif

<http://aeroponicsdiy.com/wp-content/uploads/aeroponics-flowchart.jpg>

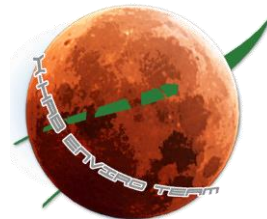

Comparison of Design Options

Table 1: Shows the advantages and disadvantages for the three systems considered.

Aquaponics	
<p style="text-align: center;">Advantages</p> <p>1) Could be made into a closed loop system with little outside input. 2) Little growth Medium required</p>	<p style="text-align: center;">Disadvantages</p> <p>1) Requires large fish population to support plant growth 2) Requires large amount of water for system maintenance</p>
Hydroponics	
<p style="text-align: center;">Advantages</p> <p>1) Very little growth medium required 2) Cheaper than Aeroponics</p>	<p style="text-align: center;">Disadvantages</p> <p>1) Nutrients must be supplied to the system 2) Requires large amount of water for system maintenance</p>
Aeroponics	
<p style="text-align: center;">Advantages</p> <p>1) Efficient water usage. 2) No growth medium required. 3) Allows simple customization of nutrient delivery to each plant type</p>	<p style="text-align: center;">Disadvantages</p> <p>1) Higher operating pressure could cause leaks. 2) System failure must be corrected within 2 hours</p>

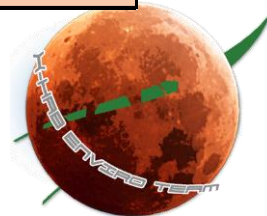

Literature Review

- Focused on automation and maintenance of aeroponic systems
- Looked for novel ways to reduce weight
- Searched for low maintenance, high yield plants
- Investigated nutrient and light requirements of plants

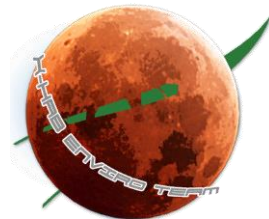

US Patent 7823328

Aeroponic System

- Describes a closed-loop aeroponic system
- Return water is filtered by column reactor
 - Bacteria to promote plant growth

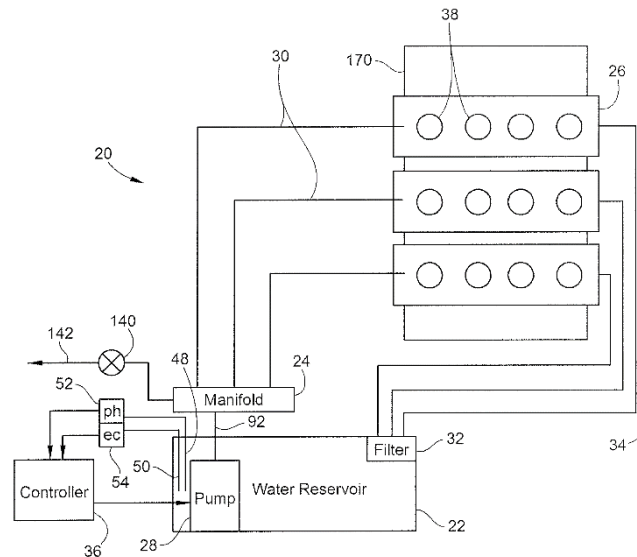

<https://www.google.com/patents/US7823328?dq=7823328&hl=en&sa=X&ei=LBxgVOPXJsaixATX4YGIBw&ved=oCB8Q6AEwAA>

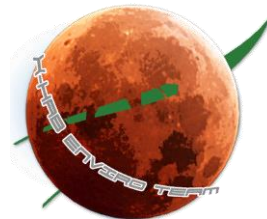

WO Patent 2014102553

Automated Aeroponic System

- Automated controls for all aspects of an aeroponic system
- Includes monitoring for system conditions
 - Water quality
 - Water distribution
 - Lighting Controls

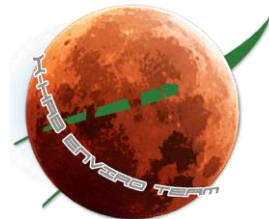

US Patent 20140144078

Modular Aeroponic System

- All aspects of the design were modular
- This reduces storage volume and simplifies installation

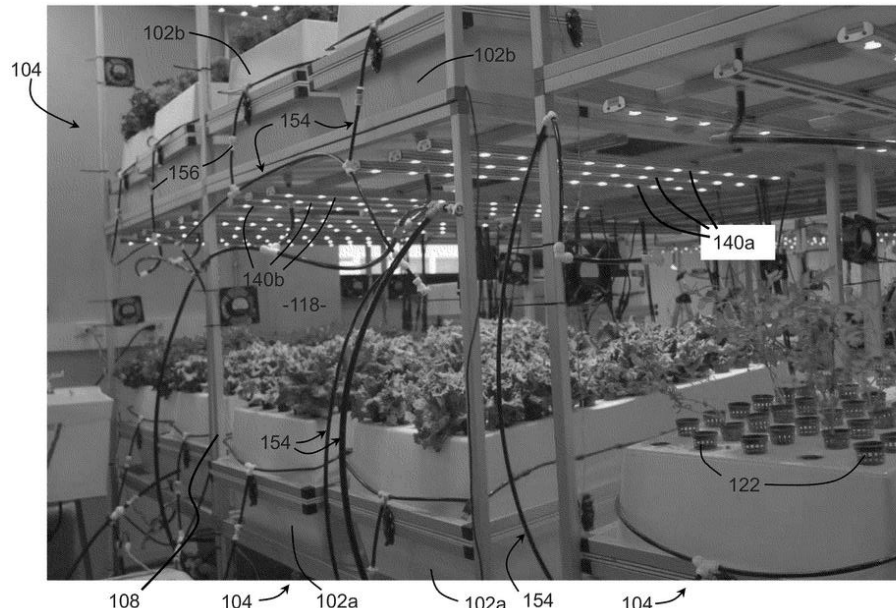

<https://www.google.com/patents/US20140144078?dq=20140144078&hl=en&sa=X&ei=RBpgVL7-H4-dygTHklDgBA&ved=0CB8Q6AEwAA>

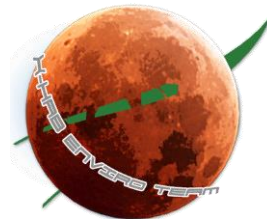

US Patent 20140137471

Novel Aeroponic Root Media

- Describes set-up for aeroponic system using cloth to hold seed during germination
 - Cloth prohibits pooling of nutrient solution

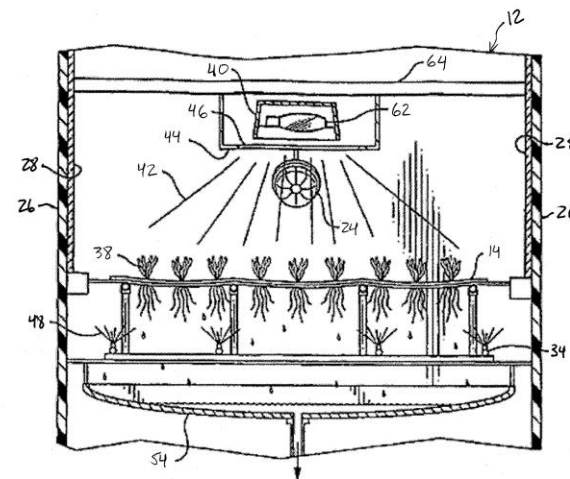
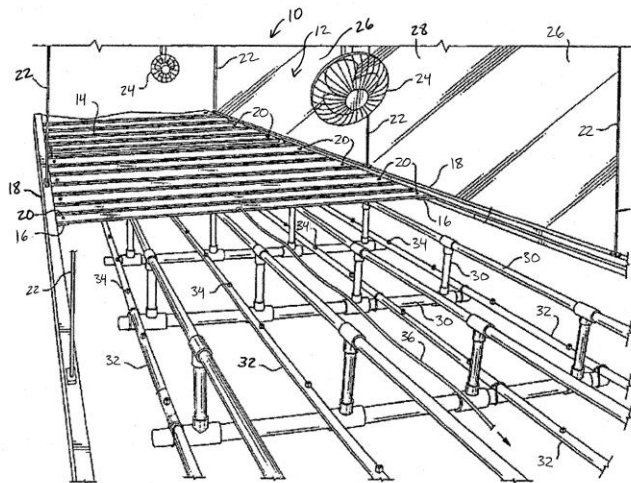

<http://www.google.com/patents/US20140137471>

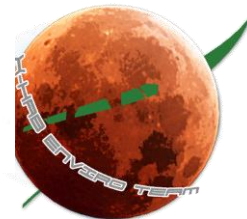

Considered Crops

- Leafy Greens: Lettuce, Spinach, Chard
- Vegetables: Broccoli, Cauliflower, Snap Peas, Green Beans, Okra, Carrots, Red/Green Onions, Cucumbers
- Fruits/Berries: Tomato, Strawberries, Blackberries

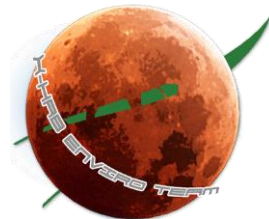

Resource Viability Index

- Rating matrix for viability of a plant
 - Each of 5 characteristics assigned a score from 1 to 5
 - Plant Yield
 - Nutritional Requirements
 - Water Requirements
 - Temperature Range
 - Maintenance Requirements
 - Scores above a 3 are considered viable

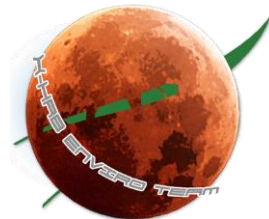

RVI: Leafy Greens

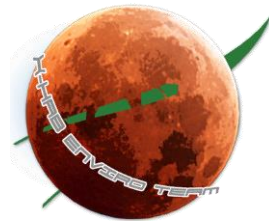
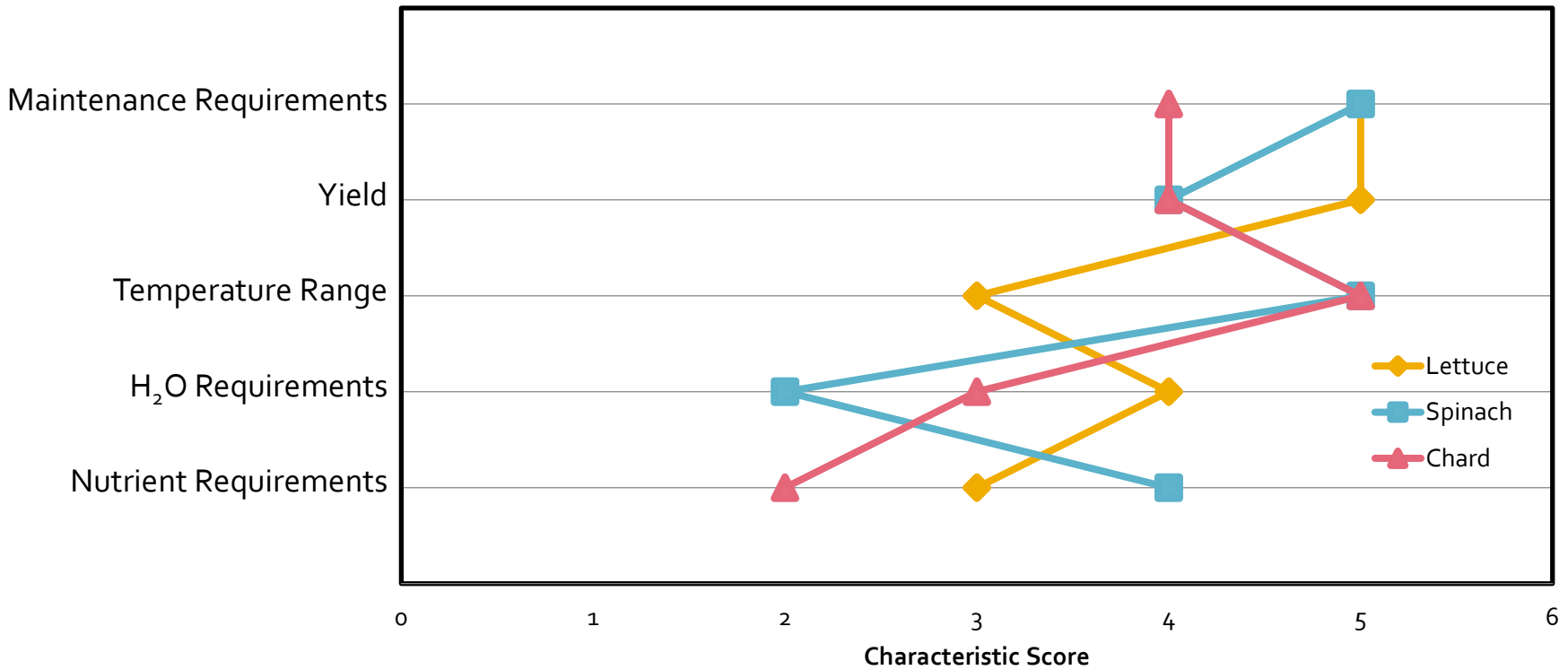

RVI: Cool Season Crops

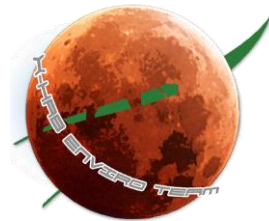
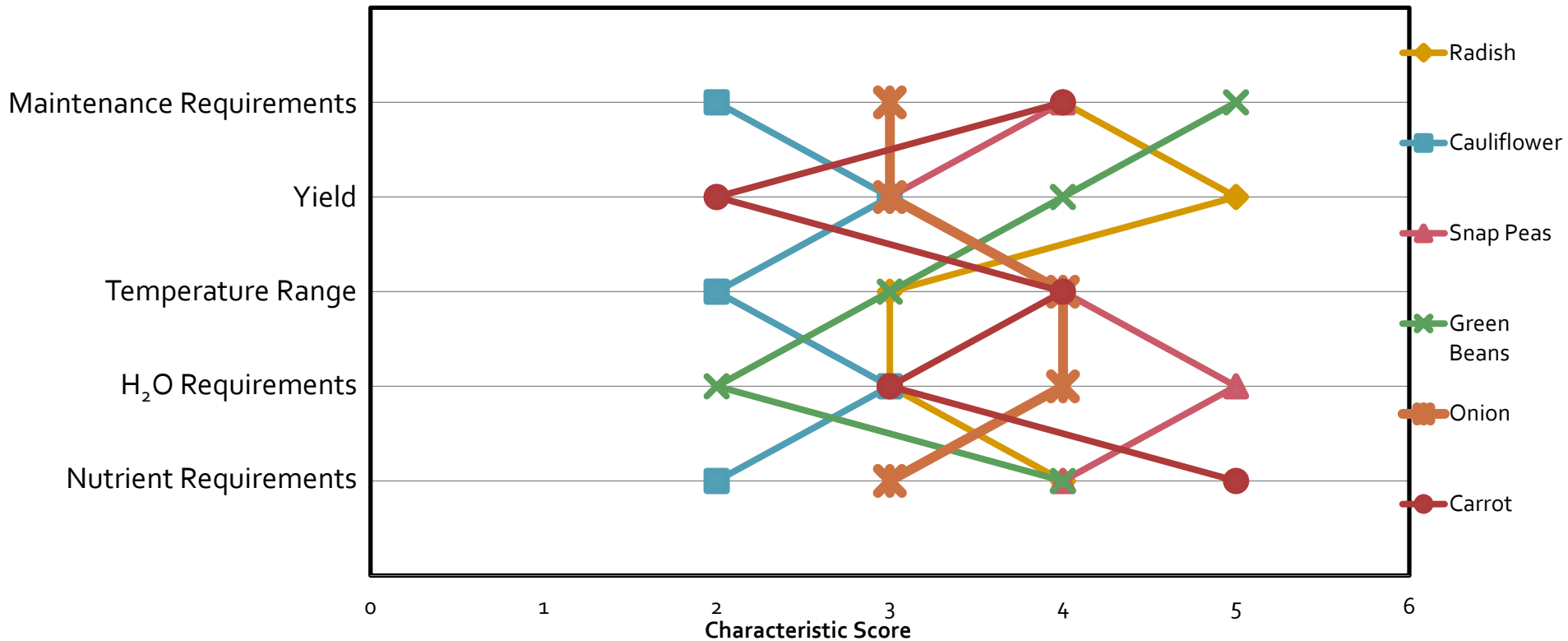

RVI: Warm Season Crops

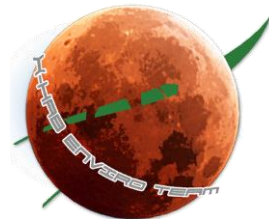
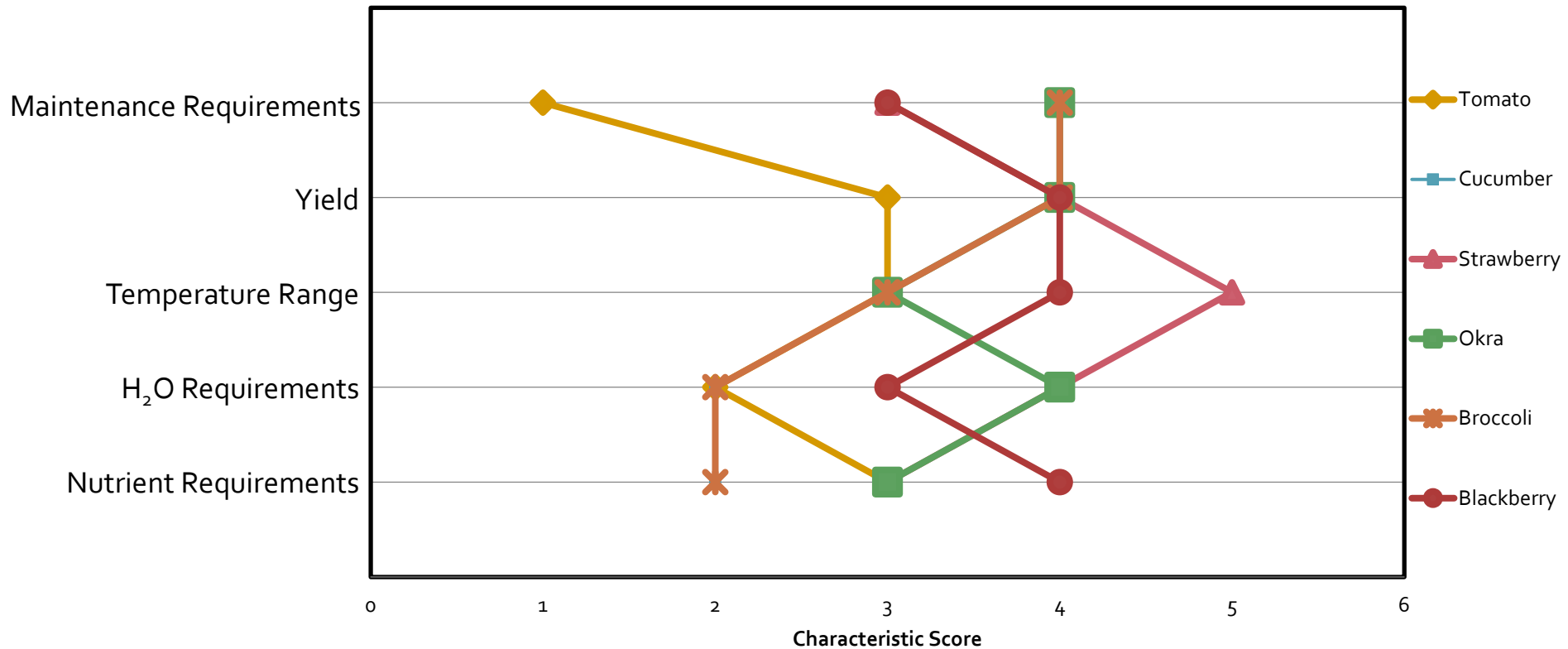

Crop Selection

- Leafy Greens: Lettuce, Spinach
- Vegetables: Carrots, Onions, Cucumber, Radish, Snap Peas
- Fruits/Berries: Strawberries, Blackberries



Redgardens.com



Plantfinder.com



Burpee.com

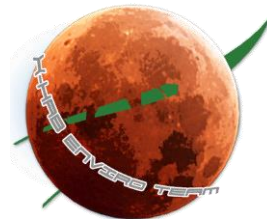

RVI: Selected Crops Average

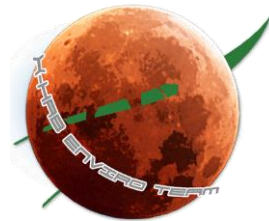
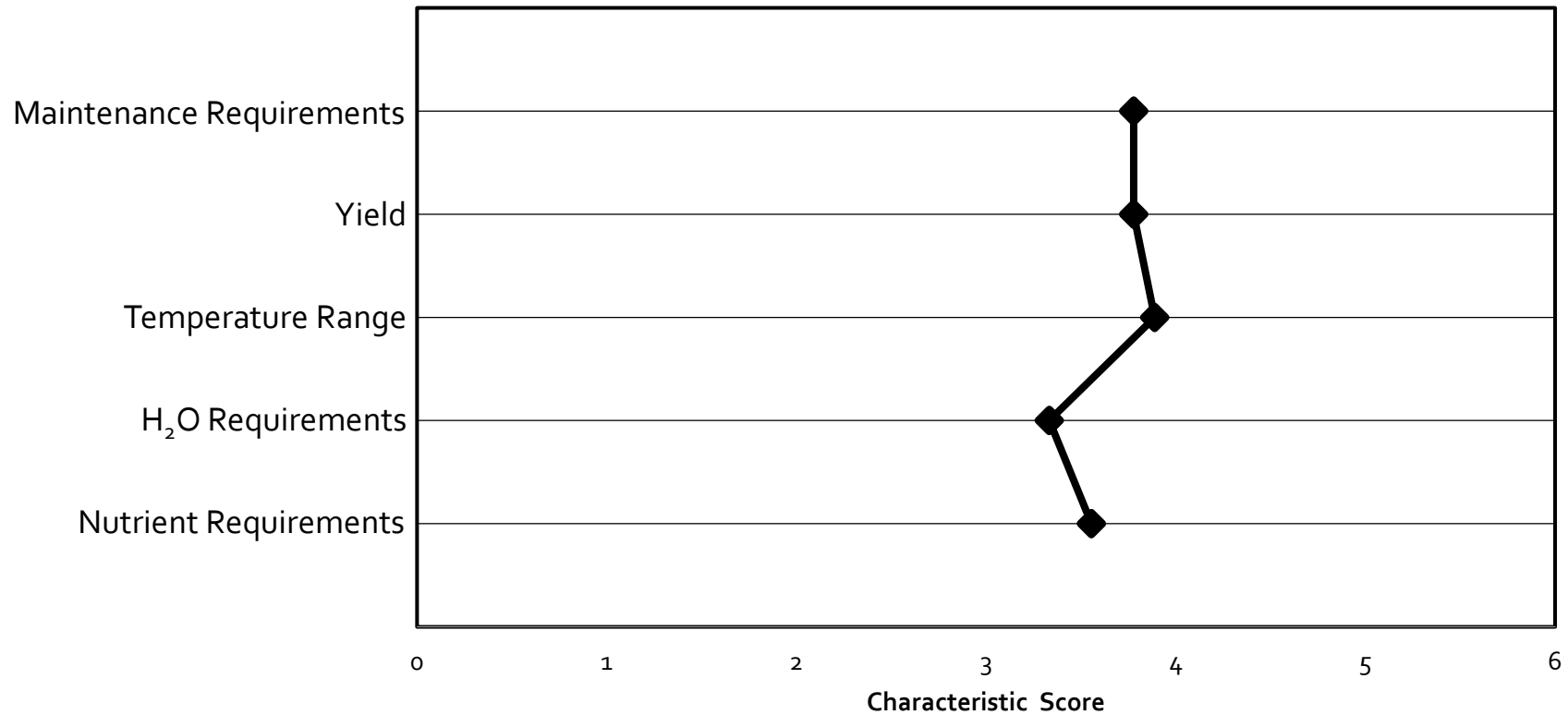

Plant Requirements

- Atmosphere
 - Humans limit gas composition within the greenhouse

Atmosphere Requirements for Greenhouse	
Total Pressure (kPa) (MAE Design Team)	62
Oxygen (%) (MAE Design Team)	21
Carbon Dioxide Concentration (ppm) (OSHA)	< 1000
Atmospheric Temperature (°C) (Various Sources)	18-24

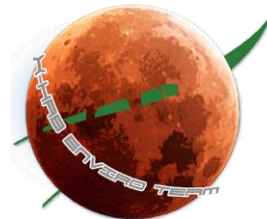

Plant Requirements

Concentrations of nutrients in commercial nutrients solutions for select crops

Macronutrients (mol m⁻³)

Crop	N-NO ₃	N-NH ₄	P	S	K ³	Ca	Mg
Tomato	11-15	1-1.5	1.5-2	3.5-4.5	5-9	3.5-5	2-2.5
Cucumber	16-18	1-1.25	1.25-2	1.25-2	5-8	3.5-4	1.5-2
Strawberry	11-13	1-1.25	1-1.75	1-15	4-6	3-3.5	1-1.5

Micronutrients (mmol m⁻³)

	FE ³	B ³	Cu	Zn	Mn ³	Mo
Tomato	20-25	30	1	5	10	0.5
Cucumber	15-20	25	1	5	10	0.6
Strawberry	20-25	15	1	7	10	0.7

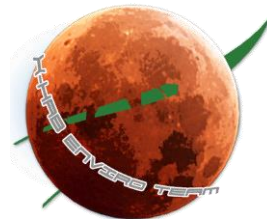

Atmosphere Regulation

- Algae will be used to balance O₂ and CO₂ levels



Byu.edu

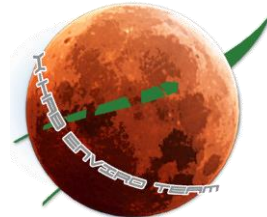

System Design Overview

- System Schematic
- Nutrient Solution (NS)
 - Composition and Monitoring
 - Solution Recirculation
 - Distribution System
- Germination
- Lighting System

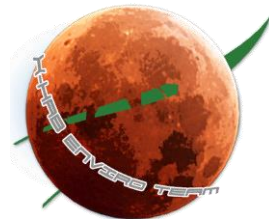

System Design

■ System Schematic

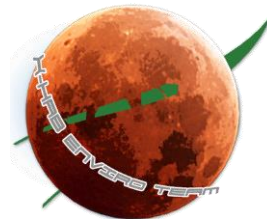
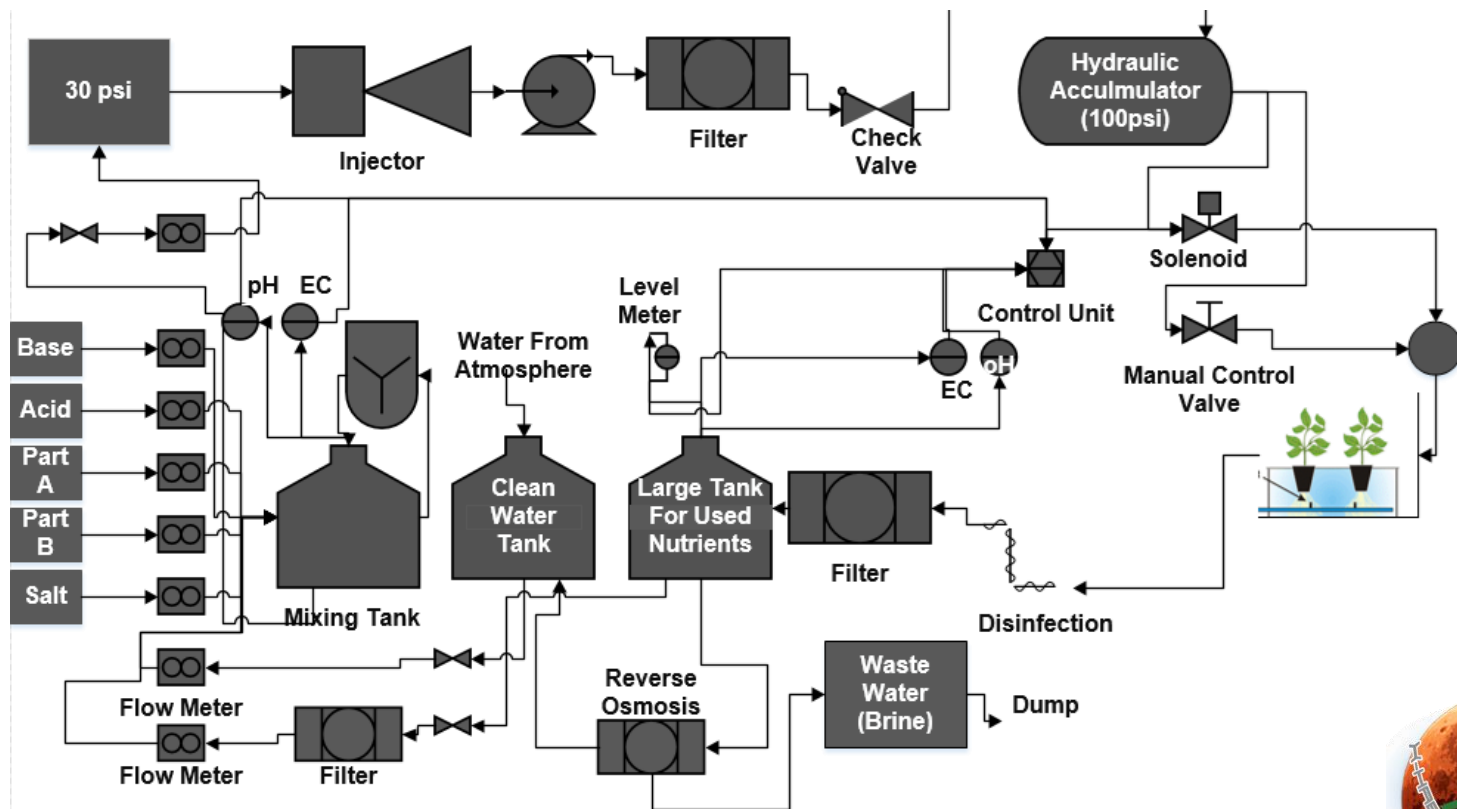

System Design

- Nutrient Solution (NS)
 - 2-part fertilizer solutions used
 - Part A – Cations
 - Part B – Anions
 - pH dictates the addition of either Part A or B
 - Part A (cations) → pH decrease
 - Part B (anions) → pH increase

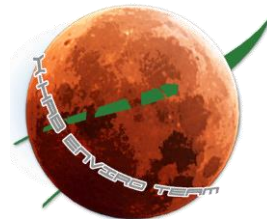

System Design

- Nutrient Solution Mix
 - Commercial products available

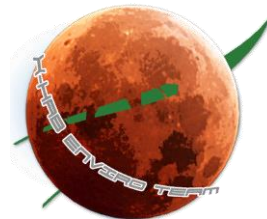

System Design

- Nutrient Solution Mix
 - Nutrient Solution Calculators Available
 - Ability to optimize for individual plants



The screenshot displays the SMART! software interface, divided into two main panels: "Insert Target Values" on the left and "Tanks" on the right.

Insert Target Values Panel:

- Buttons: "Load Crop", "Application Freq... 180.00 days", "Split/Multiply Application".
- Form: "Select Units" set to "kg/ha".
- Table: "N Forms" with columns for Total N, N-NO3, N-NH4, N-NH2, P, K, Ca, Mg, S, B, Fe, Mn, Zn, Cu. Target values are entered in the "Target Values" row.
- Form: "Crop Information" for "Apricot" with fields for Name, Variety, Plants/ha, Fert. Application Method, Growing Method, Yield Goal, and Stage/Recommendation.
- Image: A photograph of three ripe apricots.
- Button: "Adjust by Soil/Tissue Test".

Tanks Panel:

- Buttons: "Auto Fill Tanks", "Manual Fill Tanks".
- Form: "Selected Fertilizers" list including Calcium Nitrate, Potassium Sulphate, Magnesium Sulphate, Mono potassium Phosphate (M.K.P), and Fe-DTPA 11%. Each has a "Used In Tank" indicator.
- Form: "Tanks Distribution" for three tanks. Each tank shows "Water" (1000.00 l), "Liquid Fertilizers" (0.00 l), and "Tank Volume" (1000.00 l). Below each is a table of fertilizers and their volumes.
- Form: "Number of Tanks" (3), "Water minimum temperature (c°)" (5), "Water with Fert. (m3/ha)" (800.00), and "Estimated Irr. Water EC" (2.87 dS/m).
- Buttons: "Fertilizers", "Save", "Save and Print", "Exit".

System Design

■ Nutrient Solution (NS) Recirculating

- NS runoff captured and stored
- Used NS used as base nutrient solution
 - pH corrected to replenish used nutrients
 - EC levels monitored to ensure quality

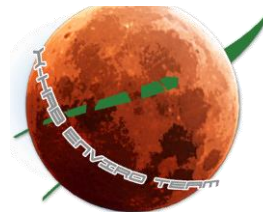
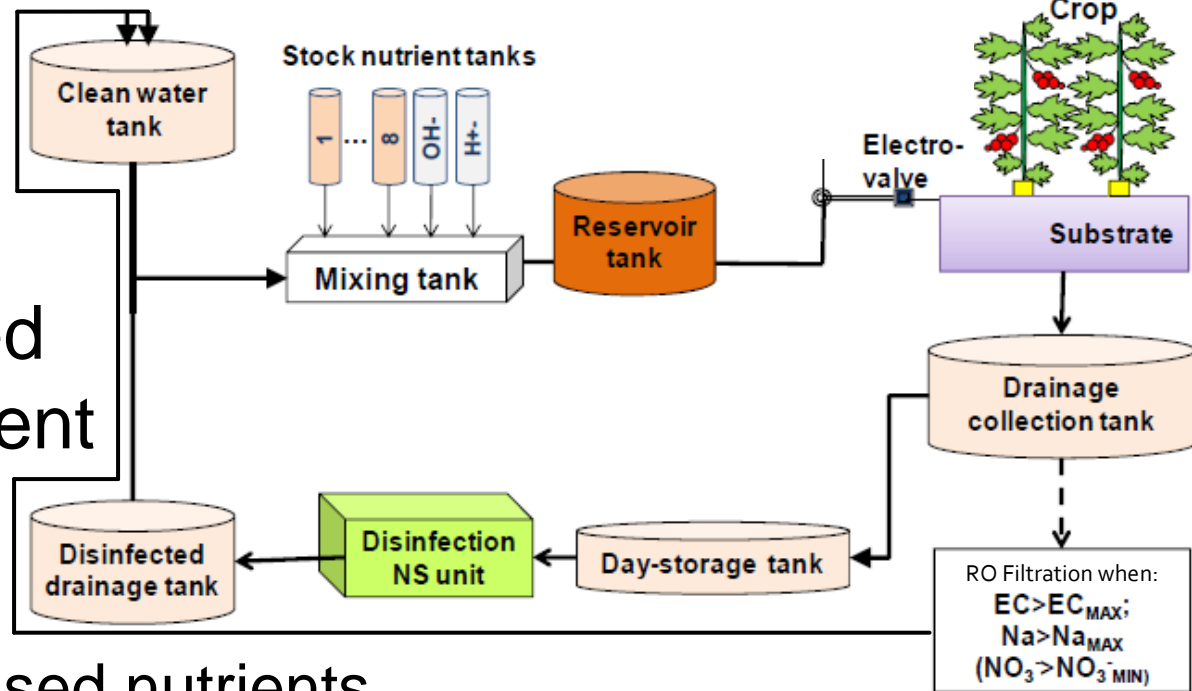

System Design

- Reused Nutrient Solution Monitoring
 - EC and pH used to monitor nutrient solution
 - pH range of 5.8 to 6.3
 - EC_{max} plant species and plant stage dependent
 - Reused nutrient solution volume reduced 50% when $EC > EC_{max}$
 - Field test kit for nitrogen

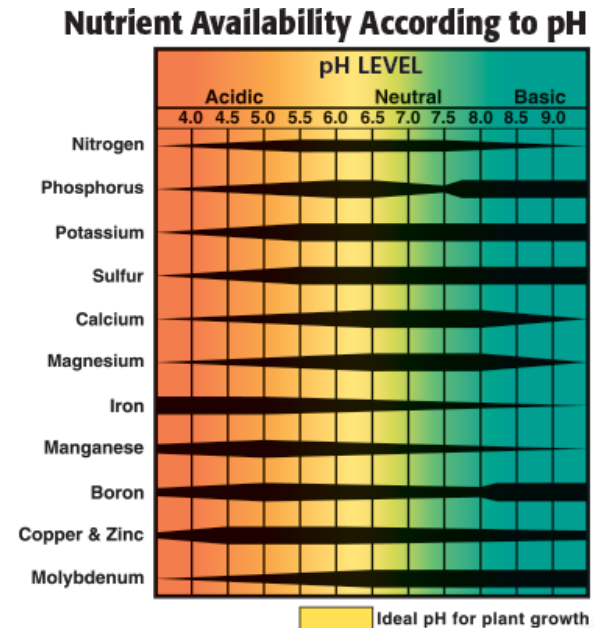

<http://blog.100bulbs.com/wp-content/uploads/2014/10/phelements.png>

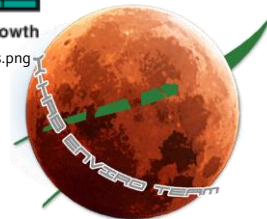

System Design

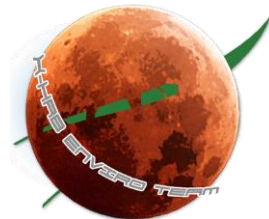
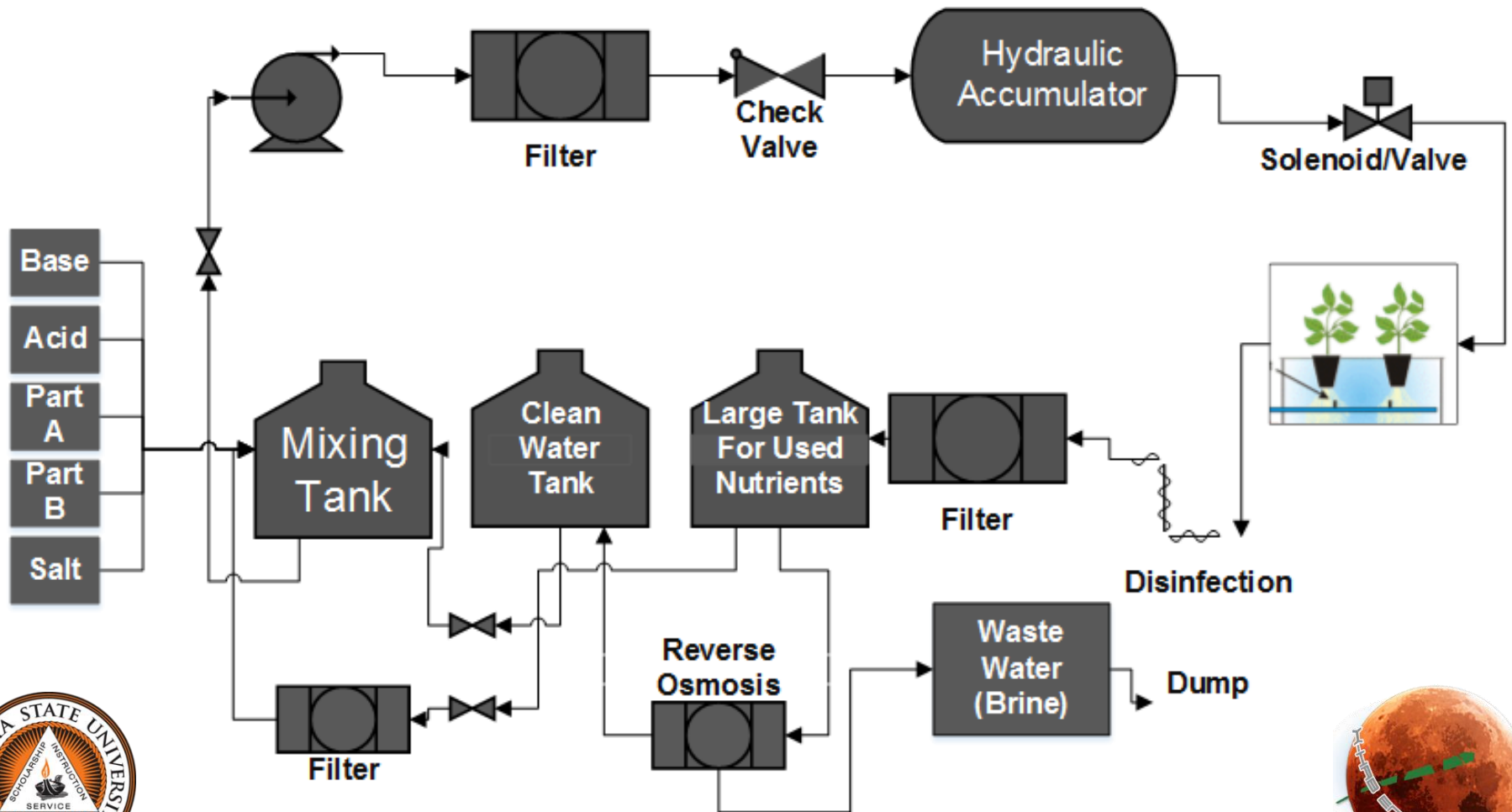

System Design

- Nutrient Solution Water Reclamation
 - Water condensed from GreenWing atmosphere
 - Reverse Osmosis system used to filter out nutrient solution
 - Treated water returned to water supply
 - Frequency dependent on salt buildup rates
 - Brine removed from system

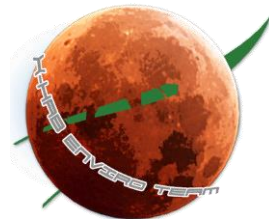

System Design

- Nutrient Solution (NS) Distribution
 - Controller used to distribute NS to bladder tanks in GreenWing
 - Bladder Tanks
 - Stores NS at 100 psi
 - Located at end of each row
 - Can be used in power outage

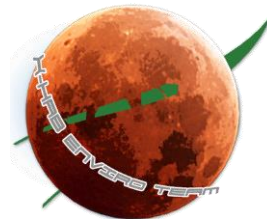
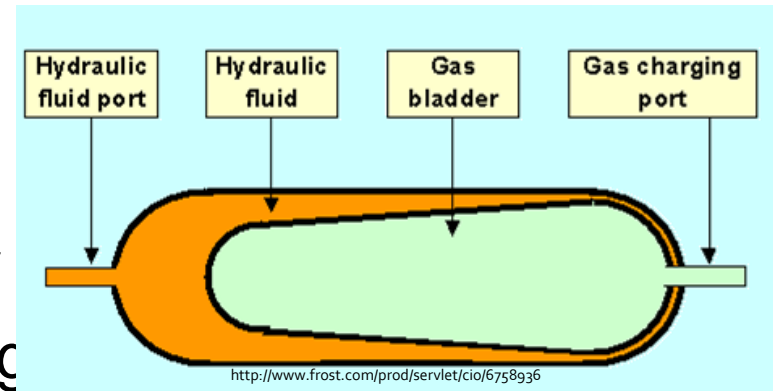

System Design

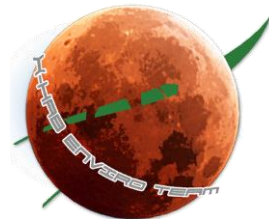
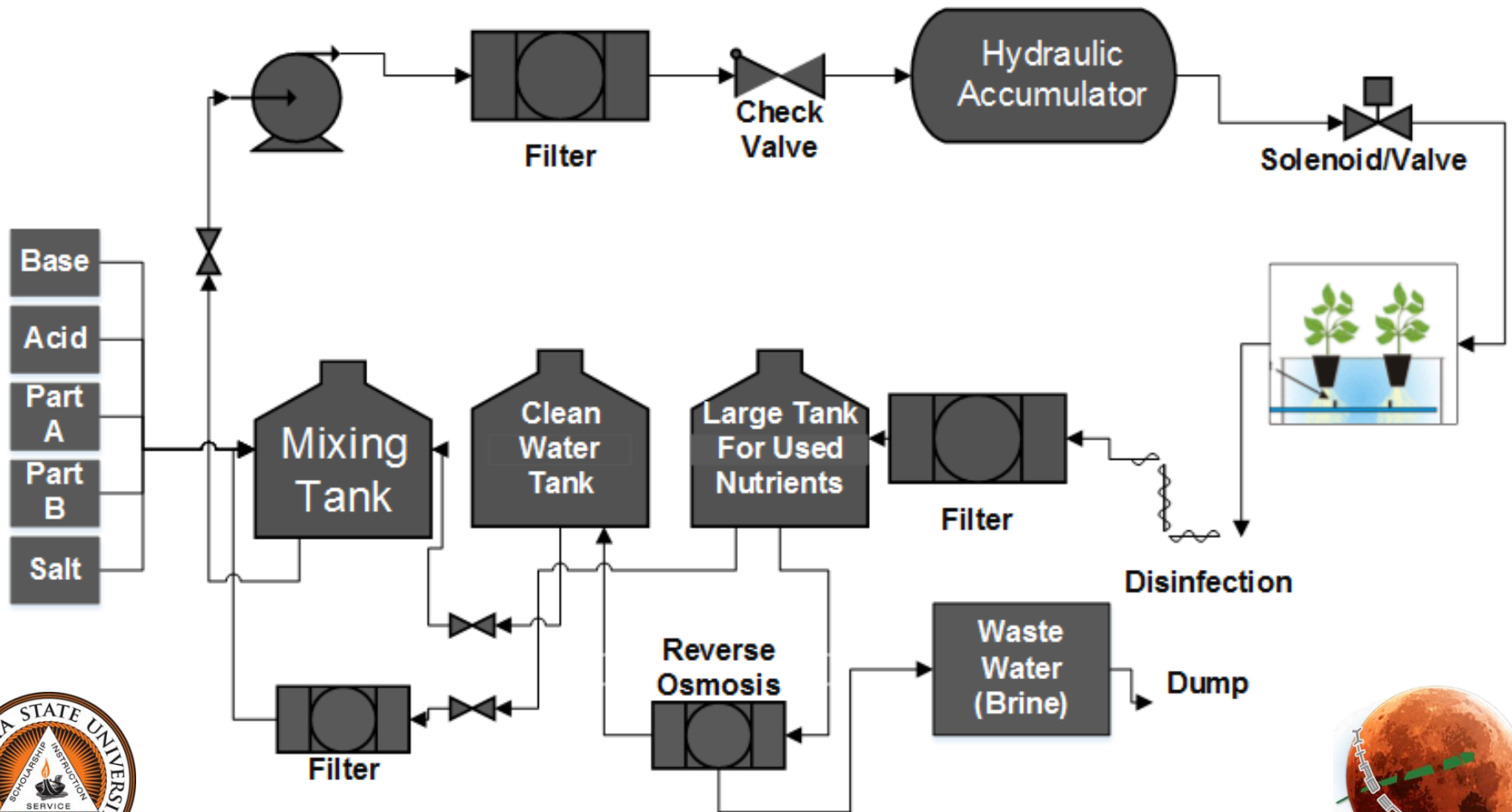

System Design

- Plant Germination
 - Growth plug allows in-system germination (peat, rockwool cubes, or aeropad)

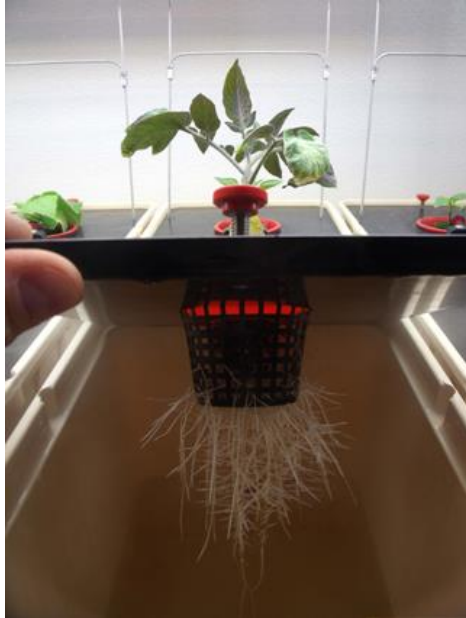

<http://aeroponics.com/current/AeroPad-Broccoli.jpg>



<http://aeroponics.com/current/AeroPad-Broccoli.jpg>

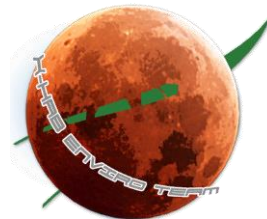

System Design

- Lighting System
 - LEDs to reduce energy consumption
 - Optimal wavelength between 400 and 720 nm



Source: Lumigrow.com

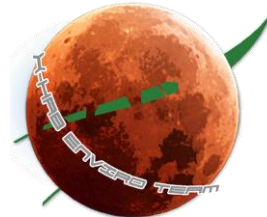

Risk Analysis

- Power Loss
 - Potential for plant death due to lack of water
 - Will affect instrumentation
 - Algae consumes oxygen in low-light settings
- Water Loss
 - Evaporation could cause lethal nutrient build-up
 - Limited fresh water supply
- High Pressure Lines
 - Increased chance of leaks

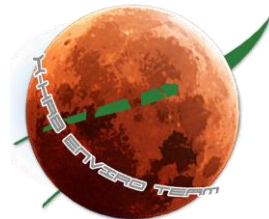

Risk Analysis

- Crop Fatalities
 - Not all plants will achieve maturity
- Automation Issues
 - Temperature and nutrition critical to production
 - Electronic failure or instrument malfunction

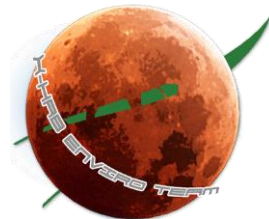

Risk Analysis

- Plumbing Deployment Failure
 - Lack of proper inflation
- Material Failure
 - Could lead to improper deployment
 - Difficult to construct/repair on Martian surface
- Plant Disease and Pests
- Other Risks

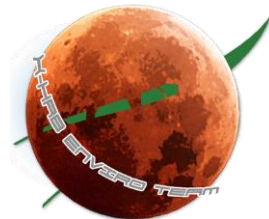

Risk Mitigation

- O₂ and CO₂ Levels
 - Algal control system
- Power Failure
 - Back up watering system
- Water Loss
 - Reverse osmosis from nutrient stream waste
 - Capture from atmosphere
- High Pressure Lines
 - Regular Inspection

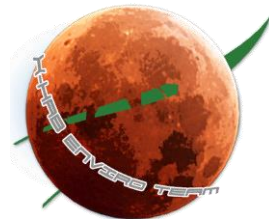

Risk Mitigation

- Crop Fatalities
 - Extra seeds will be transported.
- Automation Issues
 - Redundant controls will be programmed
 - Manual systems will be in place
- Plumbing Deployment Failure
 - Manual deployment option

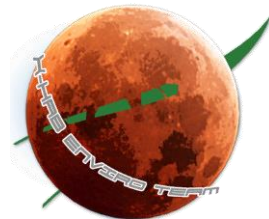

Risk Mitigation

- Material Failure
 - Manufacture for quick and easy repair
- Plant Diseases and Pests
 - Infected plants isolated and destroyed
 - Nutrient Solution distribution system sterilized
- Other Risks
 - Care will be taken to provide for unforeseen risk

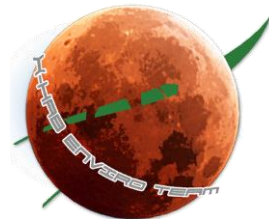

Test Unit- Spring Semester

- GreenWing constructed for testing
 - Check deployment, automation, and systems
- System Components
 - Shelving unit
 - Lighting and HVAC controls
 - Aeroponics Systems
 - Control Unit

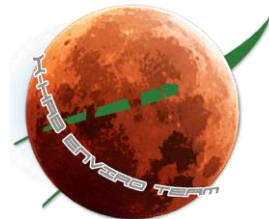

Proposed Budget

Table 3. Estimated budget for prototyping

Component	Price (\$)
20'-3" SCH 80 PVC	75.00
20'-2.5" SCH 40 PVC	63.40
20'-2" SCH 80 PVC	54.15
10'-1.5" SCH 80 PVC	\$19.94
20'-1" SCH 80 PVC	\$24.01
Water resistant fabric (2 yd.)	32.00
Spray jet for aeroponics	9.95/jet
3/8" tubing	19.55/100ft
Bladder Tank	152.50
PD piston pump (5.4 gpm)	200.00
Solenoids	5-20/solenoid
Total Price	

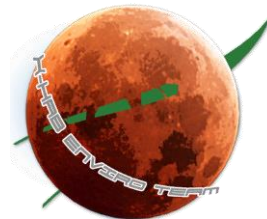

Proposed Budget

Table 4. Estimated budget for NASA mission

Component	Price (\$)
40'-3" SCH 80 PVC	150.00
40'-2.5" SCH 40 PVC	126.80
45'-2" SCH 80 PVC	117.25
30'-1.5" SCH 80 PVC	59.82
50'-1" SCH 80 PVC	60.02
Weather resistant fabric (6 yds.)	96.00
Sprayer jet for aeroponics	9.95/jet
3/8" Flexible tubing	19.55/100ft
Bladder Tank (2)	305.00
Solenoids	5-20/solenoid
Pump	200 each
Tank system for Algae	100.00
Total Price	

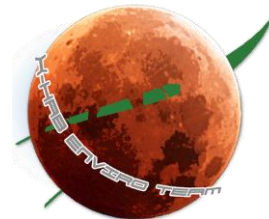

Automation

- Programming of all sensors and controllers will be performed in conjunction with BAE 3023, Instrumentation and Controls
 - Lighting rotation, nutrient composition, and nutrient distribution will be automated

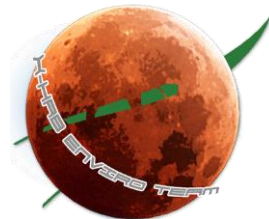

Spring Semester Plan

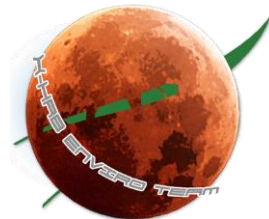
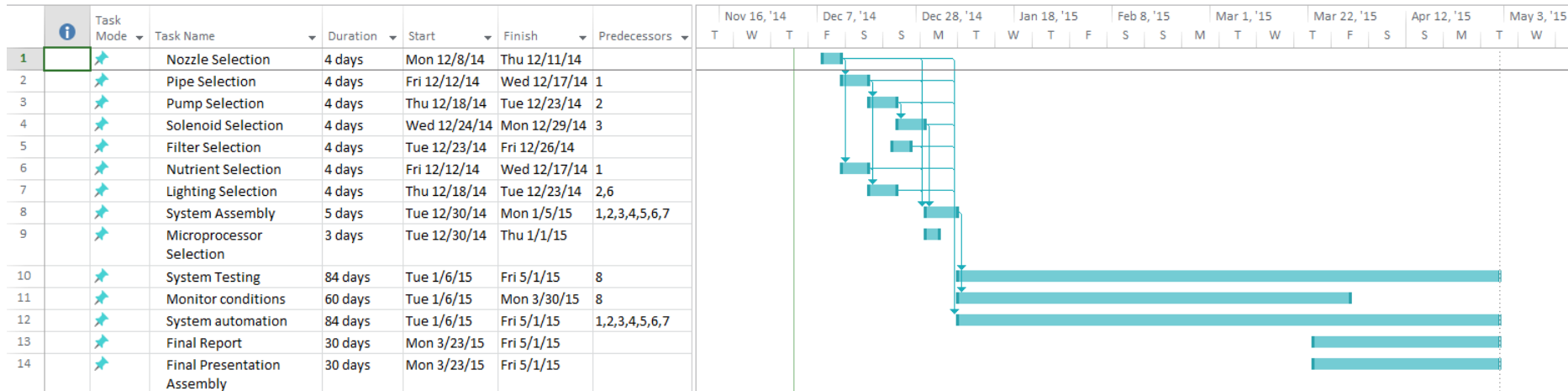

Project Milestones

- **GreenWing Construction**
(BAE+MAE)
 - March 2015
- **GreenWing Testing**
(BAE+MAE)
 - April 2015
- **GreenWing Demonstration**
(BAE+MAE)
 - May 1, 2015
- **Departmental Presentation and Demonstration**
(BAE)
 - April 30, 2015

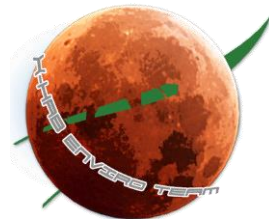

Questions?

