



## Design of a Soil Conditioner

Jacob Huff  
Jared Kinder  
Colin Lowe  
Jace Reed  
Paula Smithheisler

2011 Final Design Report

Prepared for The Vassar Company

---

## Table of Contents

|   |    |
|---|----|
| Introduction to Problem .....                     | 1  |
| Problem Statement .....                           | 1  |
| Statement of Work .....                           | 1  |
| Scope of Work .....                               | 2  |
| Delivery Schedule .....                           | 2  |
| Location of Work .....                            | 2  |
| Acceptance Criteria .....                         | 3  |
| Special Requirements .....                        | 3  |
| Work Breakdown Structure Task List .....          | 3  |
| Competitive Environment .....                     | 3  |
| Industry Analysis .....                           | 4  |
| Customers/Buyers .....                            | 8  |
| Client Company/Agency and Its Resources .....     | 10 |
| Selected Competitor Review .....                  | 12 |
| Design Aspects .....                              | 17 |
| Patent Searches .....                             | 17 |
| Relevant Standards .....                          | 19 |
| Preliminary Testing and Experiments .....         | 19 |
| Design Concepts .....                             | 20 |
| Concept Development .....                         | 20 |
| Safety .....                                      | 21 |
| Final Design .....                                | 22 |
| Prototype Testing .....                           | 25 |
| Recommendations .....                             | 27 |
| Engineering Specifications .....                  | 27 |
| Environmental, Societal, and Global Impacts ..... | 28 |
| Proposed Media Communications Plan .....          | 29 |
| Sales Objectives .....                            | 31 |
| Proposed Business Plan .....                      | 32 |
| Bibliography .....                                | 34 |
| Appendices .....                                  | ii |

---

## **Introduction to Problem**

---

The Vassar Company, located in Perkins, Oklahoma, is an equipment manufacturer for the farm and small-scale construction industries. A number of their products are versatile enough to be used by landscapers and acreage owners, and for agricultural and industrial purposes. They rely on distributors and equipment dealers to sell their products, doing very little marketing in-house. The company was founded in 1940 by I.D. “Jack” Vassar, and is managed today by Jack’s son and granddaughter, Jack K. and Jacque Vassar. The Vassar Company (Vassar) is known for their well-crafted equipment, and is looking to expand into other markets.

### **Problem Statement**

Diller Designs is tackling a challenge for the landscape industry. Vassar has assigned us the task of designing a powered multi-purpose implement for soil conditioning and seedbed preparation. The design will be innovative, but comparable in features and quality to the competition, while priced to sell to landscape contractors and construction companies.

### **Statement of Work**

#### **Background**

The Vassar Company desires a soil conditioner that attaches to skid steers to compete with other manufacturers’ ground preparation tools. Soil conditioners are used for soil preparation by landscape designers, sod layers, golf turf managers, construction workers and large acre homeowners. Current models on the market specialize in soil tillage, rock and debris collection, or soil smoothing and finishing. Vassar’s model will be suitable for both tillage and soil finishing.

## Scope of Work

- Diller Designs submitted a design proposal at the end of the fall 2010 semester that included:
  - Team and Project Overview
  - Industry Analysis
  - Engineering and Design Concepts
  - Proposed Communication Plan
  - Proposed Business Plan
- The spring 2011 semester concludes with submission of the prototype to Vassar

Equipment and this record, which includes:

- Engineering and Technical Specifications
- Product Plan
- Enterprise Budget
- Comprehensive Marketing Plan

## Delivery Schedule

| Deliverables         | Date   |
|----------------------|--------|
| Competitive Analysis | Oct 22 |
| Fall Report          | Dec 9  |
| Fall Presentation    | Dec 9  |
| Design Review        | Feb 25 |
| Spring Report        | Apr 28 |
| Spring Presentation  | Apr 28 |

## Location of Work

Diller Designs completed product analysis experiments of both competitors and the prototype at the Cowboy Motorsports test track. Design development was completed in OSU

BAE (Biosystems and Agricultural Engineering) computer labs. Vassar plasma-cut the parts, which we assembled into the soil conditioner in the BAE shop and then returned to Vassar for painting.

### **Acceptance Criteria**

Acceptance will be contingent on the final design and performance of the prototype. The task was to create an implement that does not limit itself to one function, such as rock collecting or soil smoothing, within size parameters described below. The quality of design and workmanship must also correlate with Vassar's reputation for rugged reliability.

### **Special Requirements**

Vassar would like Diller Designs to produce an implement 6 feet in length (compatible with an average skid steer) which can be manufactured using as many parts from the current inventory as possible. The implement will have a quick-attach hitch to connect to a skid steer using the industry standard, ISO 24410:2005, and use standard skid steer

### **Work Breakdown Structure Task List**

Our Work Breakdown Structure is a graphical organization of the tasks necessary to complete the engineering, economic, and communications project development. The full breakdown of tasks for the initiation, planning, design, implementation, management, and closing of the project is in Appendix 1.

### **Competitive Environment**

---

Customers use soil conditioners when it is time to prepare an area of soil for building construction or for landscaping installation. A soil conditioner similar to the observed designs

can be used for soil preparation or as a finishing tool. As a soil prep tool, it will clear grass, rocks, and debris from the site, break up the top layer of soil, and fluff, smooth, and level the surface. It can also be used just prior to grass seeding to create an ideal seedbed. As a finishing tool, it smoothes and levels the soil, clearing away debris.

## **Industry Analysis**

This project is most influenced by two distinct industries: equipment manufacturing, as a product of Vassar, and landscaping, which make up the largest number of soil conditioner users. The project is also influenced by the construction industry, another target market.

The IBIS World report for the landscaping services industry indicates easy entry, low start-up costs, and potential for large profits for individual firms, as well as steady performance over the last few years for the industry as a whole (but expected to take off in 2011 with national economic recovery). The entire industry was expected to earn \$50.7 billion in 2010 (4.7% real decline from last year) with 25.8% coming from the design and build segment, where this product would fit. Industry results are tied to the national economy. Since consumers (both residential and corporate) view landscaping service as a luxury item, this is one of the first expenses to be cut in tight economic times and one of first reinstated when customers' financial situations improve. Landscaping has low barriers to entry compared to the profit potential, so the number of landscaping companies (potential customers of Vassar soil conditioner) is projected to increase in the next five years. Also, new home building increases with economic stability, which benefits both landscape and construction companies. Income of the more than 260,000 landscape companies is almost evenly divided across firm size, as shown in Figure 1.

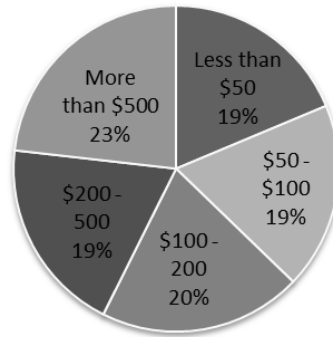

Figure 1. Firm Distribution by Annual Income (in thousands) of United States Landscapers

This even distribution suggests there is no concentration of firm size, and no concentration of market power by any individual companies (IBIS World 56173, 4-17). Vassar therefore has a wide range of customers in the landscape industry, both geographically and by size.

Another important industry highlighted on IBIS World is Farm, Lawn, and Garden Equipment Wholesaling – a close fit for Vassar as a company. According to the IBIS report, lawn and garden equipment sales have been suffering with the economic situation, like the landscaping industry. The report predicts steady sales for the rest of 2010, but accelerating revenues in 2011 with increased sales to the housing market and noting an aging population that will soon have time in retirement to return to yard work (IBIS World 42182, 6-16). Retired homeowners are not likely the final customers of soil conditioners, but their interest in gardening or outdoor entertaining could stimulate use of landscapers to prepare yards. The report also suggests that equipment rental companies will become a larger customer base for lawn equipment (IBIS World 42182, 17).

IBIS World reports on a number of related industries, all affected by the economy. Land & Outdoor Equipment Retail – referring to specialized stores – for instance is experiencing a

price-driven market, thanks to greater competition from Wal-Mart and home supply stores as homeowners are looking for less expensive products. Due to this shift in consumer purchases (and subsequent effects of consumers' tendency to maintain their habits as long as the product quality is similar), this industry is declining overall (IBIS World 44421). Luckily, these trends are not common in the landscaping equipment sector. Land development is expected to increase with the economic recovery as developers become more confident about building homes and offices (IBIS World 23311). The industry report for Tractors & Agricultural Machinery predicts a strong global demand from agricultural success (IBIS World 33311). This also does not directly affect this project, but success may affect manufacturing decisions of those companies that produce both agricultural and landscaping equipment, changing the competitor dynamic.

Overall, the project's economic outlook is positively related to the economic conditions of the United States, since customers' demand for landscapers is related to their disposable income and time to do yard work themselves (IBIS World 56173, 12). The manufacturing of the conditioner will follow trends in the manufacturing industries, but the economic outlooks of its target industries' markets – construction and landscaping – are important to our marketing plans.

Governmental and industry regulations for the most part do not affect this product. Phase II of the National Pollutant Discharge Elimination System (concerning pollution via water runoff) could be significant, if the job site in question is over an acre in size. Landscapers are subject, like other employers, to labor laws and immigration issues. Other major concerns for the landscaping industry – engine emissions and pesticide use – are less pertinent to this particular product.



Pertinent industry standards relate to the attachment of the implement to the skid steer. The attachment standard (ISO 24410:2005) is discussed in greater detail later. Design standards do not exist for soil conditioners.

Research was also engaged to find the perspective of the potential customer. IBIS World states 19.3 percent of landscape companies have up to two employees, 21.7 percent have three to four employees and 28.2 percent have between five and nine. This small scale, along with the low barriers to entry described earlier, suggest that landscapers operate in a narrow geographic region. These landscapers are members of state and regional industry groups, many of which hold annual conferences and trade shows. Two of the largest nationwide shows are the GIE+Expo, held in Louisville, Ky., every October and the Landscape Industry Show held in late January or early February in Los Angeles, Calif. A listing of regional associations and their trade shows are in Appendix 6.

There are many trade publications applicable to these industries. Landscapers have the choice of *Landscape Management*, *Lawn & Landscape*, *Green Industry Pro*, *Turf*, and *Total Landscape Care*. Applicable sources, articles, or advertisements can be found in *Commercial Dealer*, *Compact Equipment*, and *Equipment World*. All of these are references for industry attitudes, and potential avenues for advertising.

Diller Designs does not expect physical resources to be limiting to this project. The necessary manufacturing resources are steel and other materials for production, and labor to run the machines and assemble finished products. Users of the product will need a skid steer (which requires fuel and labor to operate) and a job site. The product will be applied to new construction sites or to residential lawns, neither of which will be limiting nationwide.

## Customers/Buyers

The IBIS Report on Landscaping Services indicates landscape customers are driven by price, resulting in high sensitivity by contractors to operating costs, in order to stay competitive (IBIS World 56173, 4).

The financial difficulties of individuals or businesses who typically hire landscapers have affected the industry. Page 4 of IBIS World 56173 says the following:

“The perception that landscaping services is a luxury and discretionary service means that in harsh economic conditions, client expenditure is reduced and priced based competition rises in intensity.”

The current economic situation has caused them to be more sensitive to expenses, which has in turn created a cost-sensitive industry of landscapers. Buyers of the Vassar soil conditioner are sensitive to not only cost but also quality, because design flaws delay jobs and increase costs.

New construction is also slow during this uncertain economy. Although the target customers may not be looking to invest in new equipment at the moment, landscaping and construction will pick up again when the economy recovers, recharging demand for this product. According to the American Nursery and Landscape Association, an average of 85 million households take part in lawn and garden activities (ANLA); the market for individual customers of Vassar’s product is a subset of this number.

Vassar follows a business-to-business marketing structure, as most output is sold to distributors. These distributors resell to dealers – who then sell to landscapers or construction companies or to equipment rental companies that serve these customers. Many competing manufacturers (Harley, FFC, John Deere, Caterpillar, and Nortec, for example) also market their products this way, as seen in their websites: they advertise their models and give lots of

information, but refer interested parties to a nationwide network of dealers. Some companies, such as York, include a phone number for customers to call and buy direct from the company to avoid the middle man.

It is difficult to find exact demographics of Vassar's market, because landscapers can be classified in a number of areas in the U.S. Census, from service to groundskeeper/grounds maintenance to agriculture. Many reports classify landscape services as agriculture, but searches for agricultural reports find more results from crop and livestock production than landscaping. It is known that firms employ a variety of races (Hoovers), but demographics by specific occupation are not accessible online. Landscapers' primary customers are businesses and middle-to-upper class households (IBIS World 56173) and that's as precise demographics for the final customers as we can discern.

Market research is accessible for landscaping, but much is proprietary. Our preliminary market and design research used the term 'landscape power rake' and we found many differences between regions or persons in interpretation of that term. Due to this, we changed our views of the terminology and now refer to it as a "soil conditioner," which is a less ambiguous description of the product. We also found a great online resource as we searched for information about landscapers – industry forums. Landscapers and other equipment operators discuss pros and cons of tools, machinery, brands, and general industry issues. Diller Designs asked for input in early stages of product design, and received responses from three landscapers from around the country. These conversations showed more ambiguity about the product name, but were also informative. One landscaper uses the powered lawn rake model and two use Harley Rakes (one also uses a model by Woods Equipment Company). The two relevant responses – from a landscaping company in Massachusetts and one in North Carolina – also indicated skid steers as

their primary tool (the North Carolina response indicated many competitors use skid steers as well) (GroundTradesXchange thread). Other searches of this and similar forums indicate that landscapers both buy and rent equipment.

Primary research was also done via phone calls to landscape contractors in Texas, Oklahoma and Colorado, for variety of geographic location. These phone calls reaffirmed the decision to build for a skid steer rather than a small tractor, but provided little input in design, because few of the contractors contacted have used a soil conditioner. A full listing of contractors contacted and call summary is in the appendix.

### **Client Company/Agency and Its Resources**

Vassar's management team is very concise and therefore efficient. Jack Vassar is the owner and general manager of The Vassar Company. Jacque Vassar, Jack's daughter, is the assistant general manager and daily overseer of operations in the office. Larry Johnson serves as the plant manager. Pam Graves is the payroll clerk and human resources manager at the office in Perkins, Oklahoma.

Vassar's sales team travels around the Arkansas, Mississippi, Tennessee and Oklahoma areas making contacts with potential dealers. Vassar is a farm equipment manufacturer which sells some equipment from the home location via telephone and website, but also sends products to distributors around the country. These are as follows:

Gearmore, Inc.  
Chino, CA 91710  
909-548-4848

Price Brothers  
Wichita, KS 67202-0124  
316-265-9577

Alliance Distributing  
Hewitt, TX 76643  
800-227-6367

Rankin Equipment  
Yakima, WA 98907-0168  
509-453-8271

Tri-State Distributors  
Statesville, NC 28687  
704-873-0531

Robert Laning & Sons  
Waterford, ON Canada NOE 1YO  
519-443-8601

All products are made in-house at Vassar. The manufacturing resources are stable, as materials are purchases from steel yards located in Chicago, Illinois; Houston, Texas; Oklahoma City, Oklahoma; Tulsa, Oklahoma; Muskogee, Oklahoma; and St. Louis, Missouri.

Vassar manufactures a diverse range of equipment. The products range from hay spears and tree shears to grapple claws and box blades. Most of the products fit into the lower pricing segment of the market, and are marketed emphasizing their durability and quality workmanship. Vassar will add the soil conditioner to this line-up of well-built, affordable equipment. Below is a summary of Vassar's current product line, as found in Vassar's product notebook and Appendix 2-C of this report:

Table 1. Current Vassar Products

| Vassar Equipment Product List and Prices |            |
|--|------------|
| Product                                  | Base Price |
| Disc Mower Caddy                         | tbd        |
| Compact Grapple                          | \$1,849    |
| Compact Bucket Grapple                   | \$2,083    |
| Ranch Post Hole Digger                   | \$1,216    |
| Wheel Type Tandem Disc                   | \$5,930    |
| Wheel Type Offset Disc                   | \$7,347    |
| 3-Point Tandem Disc                      | \$2,775    |
| Drag Scraper                             | \$3,179    |
| Arena Groomer                            | \$1,690    |
| Dirt Scoop                               | \$4,140    |

## Selected Competitor Review

Table 2. Major Competing Products

|               | FFC Preparator | Harley  | Stone Dawg | York                        | Bobcat              |
|---------------|----------------|---|------------|-----------------------------|---------------------|
| Width         | 6.5'           | 6'  | 6'         | 6'                          | 6'                  |
| Weight (lbs)  | 1465           | 900   | 1250       | 952                         | 1100                |
| Angle         | none           | fixed, manual or hydraulic                    | none       | manual or hydraulic         | manual or hydraulic |
| No. teeth     | 300            | n/a   | 252        | n/a                         | 141                 |
| Type of teeth | blade          | nub   | blade      | spike                       | nub                 |
| Cost          | \$9,099        | \$7,137 fixed;<br>\$7,876 man;<br>\$8,663 hyd | \$8,995    | \$7,710 man;<br>\$8,655 hyd | n/a                 |

### FFC Preparator

The FFC Preparator is sold as a clean-up, rock removal and soil preparation product (FFC Preparator). It adds rock removal – up to twenty inches in diameter – to the general soil preparation that most soil conditioners offer. The rocks are collected in the fully-enclosed bucket of the device. The Preparator comes with three different weight options ranging from 976 to 1650 pounds.



Figure 2. FFC Preparator

Source: <http://www.abcgroff.com/ic/pics/ffc1.jpg>

In early design review, the Preparator design was favored, until product testing, when larger design flaws became apparent. Small holes on top of the machine serve an important

purpose, but we only experienced the soil particle projectile capabilities of them. The roller brush inside, near the skid steer bucket, serves to smooth the soil, but clogged very quickly when tested in tall grass. This eliminates the Preparator from use in initial ground clearing.

### **Harley Power Box Rake**

Harley Power Box Rakes are the current industry leaders, offering attachments for mini skid steers, skid steers and tractors, in widths ranging from 4 to 9 feet. Options like the reversible box ends, dual independently-adjustable gauge wheels, adjustable rock barriers, and carbide teeth provide a product that helps reduce the amount of work required by users (Harley Power Rakes).



Figure 3. Harley Power Box Rake

Source: <http://www.abcgroff.com/ic/harley1.htm>

The success of Harley comes from good marketing through different methods including tutorial videos on YouTube. Harley's design will be more influential than any of the following products.

### **Stone Dawg**

The Stone Dawg, with its identical sister the Rockhound, is the least comparable product we found to be used as a reference during design. The Stone Dawg specializes in debris clearing,

as it picks up rocks from the ground and throws them into the bucket of the skid steer. It has some soil finishing ability.



Figure 4. Stone Dawg Landscape Rake

Source: <http://www.quick-attach.com/attachments/landscaperake>

A chain-link system with rake bars removes the rocks from the soil (RockHound). This design is not desirable on the basis of cost and lack of versatility.

### **York Rake**

York produces rakes in 6-8 foot models ranging from 923-1020 pounds for three-point hitch tractors and skid steers. The 3-point rakes can come with a power take-off or hydraulics.



Figure 5. York Rake

Source: <http://www.wikco.com/pwrrake.html>



The model designed for the skid steer does not have any major options which distinguish it from the crowd, but does have a simple easy-to-service design (York Landscape Rake).

### **Bobcat Soil Conditioner**

Bobcat makes a similar skid steer-mounted product, called a soil conditioner, which smoothes ruts, moves material, and levels mounds. Like the Harley Rake, it also comes with adjustable wings to move loose soil, and can float along soil topography.

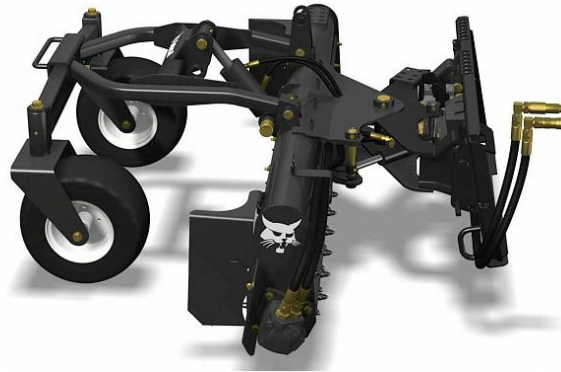

Figure 6. Bobcat Soil Conditioner

Source: [http://www.usagnet.com/manufacturers/122/soil\\_conditioner.jpg](http://www.usagnet.com/manufacturers/122/soil_conditioner.jpg)

The soil conditioner is available in widths between 4 and 7 feet, with manual or hydraulic angle controls, and in a high-flow option. Foam-filled tires prevent flats. A locking option on the drum allows the implement to be used as a box blade (Bobcat).

### **Nortec Piranha**

The Piranha, manufactured by Nortec and not listed in the table, is produced for both three-point tractors and skid steers. Widths of this machine can range from 3-8 feet.



Figure 7. Nortec Piranha

Source: [http://www.nortecmfg.com/products/LG\\_Piranha/ptx.php](http://www.nortecmfg.com/products/LG_Piranha/ptx.php)

Each model has adjustable gauge wheels, side shields, manual or hydraulic angle control, and multiple rotor options. The Piranha offers a very versatile selection, including 16 different models (Nortec Piranha), which should be taken into consideration when we begin to design Vassar's product.

### **ATI Preseeder**

The ATI Preseeder, also not listed in the table, has a simple drum rotor like the other conditioners is advertised to function well in tilling, leveling, and raking/windrowing.



Figure 8. ATI Preseeder

Source: <http://www.preseeder.com/preseeder>

There are 5 available models ranging from 5 to 7 feet and between 780 to 1225 pounds. The rake has an option to rotate 20 degrees in either direction. One option that separates the ATI

Preseeder from other rakes is a finisher roller to complete seedbed preparation (ATI Corporation).

## **Design Aspects**

---

### **Patent Searches**

The following patents are the most relevant results from searches of the United States Patent and Trade Office. Full listing of these and additional related patents are in Appendix 2-E.

#### **10,744,308 June 23, 2005**

Granted to: Caterpillar, Inc., Peoria, Ill.

This patent relates to the serviceability of implement teeth. Teeth are welded to bars, which are attached with bolts to drive chains. This patent was integral to early design concepts, but will not be integrated into the current design.

#### **6,497,294 December 24, 2002**

Assigned to: Clark Equipment, Woodcliff, NJ

This patent covers a number of design features of current models. The flip up bolster member/caster wheel adjustment (along with the adjustability of the bolster member), more aggressive drum teeth, the radial crisscrossing pattern of the teeth on the drum, replaceable shell of the drum separate from the drive axle, symmetrical drum pattern so drum can be used in the reverse direction for certain applications, and a radial float assembly (to adapt to changing directions of the skid steer) are the pertinent features described. It is important for us to know what features we might want to include that are patented, to avoid infringement.

**6,223,828 May 1, 2001**

Assigned to: Caterpillar, Inc., Peoria, Ill.

This patent relates hydraulically controlled float capability of implements, allowing them to responsively move to avoid damage to teeth by irregular objects such as large rocks and logs. This patent is interesting because of its innovation, and was pertinent to design ideas when we considered building a model similar to the FFC Preparator, but is not related to our current design.

**5,564,506 October 15, 1996**

Assigned to: Farmers' Factory Company, Rockford, Ill.

This patent covers the process of collecting rocks into the bucket and the dumping of the rocks along with the separation of the rocks and dirt. A design integrating a bucket allows for rock picking separate of the conditioner unit allows more flexibility in the product's use. Having functions separate allows each side of the rake to float over uneven ground.

**5,261,218 November 16, 1993**

Assigned to: Great Plains Manufacturing, Inc., Great Plains, Ks.

This patent covers the methods of separation of debris from the soil and the act of windrowing the debris by using adjustable tine height and a powered roller. Although this patent is from 1993, it cites marketing materials from Harley and ATI, giving time perspective to the soil conditioner or power rake market.

## **Relevant Standards**

ISO 24410: 2005

This standard sets forth standard dimension requirements for the loader attachment bracket and attachment interface to allow interchangeability of attachments on skid steer loaders whose operating mass is 4,500 kilograms (9920 pounds) or less. Narrow skid steer loaders may have a width that does not allow compliance with this standard. The design of the loader attachment bracket locking system is not restricted by this standard and is left to the discretion of the manufacturer. It is not applicable to attachment interface brackets connected to the attachment bracket by a lateral locking system.

This standard also supersedes the SAE J2513 standard, which described the same process, and is listed in the appendix instead of the ISO standard, for ease of procurement.

## **Preliminary Testing and Experiments**

Field testing offered a first-hand understanding of the capabilities and operations of current landscape rakes and soil conditioners. After market research, two current models were chosen to observe – Harley’s Power Box Rake and FFC’s Preparator – on the track of Cowboy Motorsports on November 7, 2010. Ditch Witch of Perry, Oklahoma, offered a similar prototype developed by their engineers to add to our testing. During testing, different design aspects were considered by the engineering specialists of Diller Designs.

The characteristics observed during field testing were overall performance, maneuverability, ease of service, windrowing and rock collection efficiency, and operating specifications such as tillage depth and aggression. No quantitative data was collected, just

observations. Vibration was noted by the skid steer operator, as was the amount of headland required for turning. In testing serviceability, we found how accessible inner workings were and determined that everything seems to be easily accessible and identified the permanent and replaceable parts. These trials, as well as an overall evaluation of performance, were conducted over a variety of terrain, including grass, cleared ground and tilled/loose soil.

The Harley Power Box Rake performed the best of the three. The best features about the Harley were the soil condition after use, ease of maneuverability, and the tooth design. Some disadvantages include slow-to-adjust hydraulic angling, shallower depth of tillage than the other two, and difficulty keeping the machine level over uneven ground.

The FFC Preparator, which we originally planned to use as a starting point, works well at removing debris from the surface, but came with many disadvantages. As mentioned earlier, the machine frequently discharged soil particle projectiles, and the efficient debris removal resulted in the need to dump the bucket often. The brush roller clogged easily in grass and did not give a visible difference in smoothness of bare soil. Finally, the depth of tillage was not satisfactory.

## **Design Concepts**

### **Concept Development**

The attachment can be broken down into 5 components:

1. Floatation
2. Drum
3. Teeth
4. Drive
5. Angle

From testing, we saw that tilt and height were hard to adjust to the correct positions on the Harley rake. With this knowledge, we looked at different methods of floating the attachment as opposed to the majority of the competitors that had rigid frames. Drum diameter was another

focus of the team. Larger drums allow for more depth of penetration and more teeth, but raise the cost of materials.

The majority of the competitors use a carbide-tipped tooth similar to what would be used in post-hole augers drilling bits. These teeth are expensive and hard to come by, which prompted research for other types of teeth. The layout of the teeth was another also a major focus for us as well. Our first layout included a helix of alternating carbide and steel teeth. We then rejected the carbide teeth, and left the steel teeth in a helix. To make assembly easier, we put the steel teeth in straight and offset rows.

Another design that was evaluated was to either have a direct or chain drive system. Both of these have their advantages of cost and functionality. Finally we looked at whether to have an angle adjustment or to be fixed and if we did use an angle would it be powered or manual.

## **Safety**

There are a few pinch points that could not be avoided in the float design. However, the skid steer operator will never be out of the machine while it is in motion so these pinch points are not a major issue. Debris from the machine is the significant safety concern, for not only the operator but also bystanders and personal property. To prevent flying debris, a rock guard made up of a metal shield and a rubber flap was designed for the lower side of the main frame. This will not completely stop all projectiles but will greatly improve human safety. An expanded metal chain guard was attached to the side plate of the frame to prevent other workers from getting fingers or clothing entangled in the chain drive system.

## Final Design

The final design follows the design criteria that were set by Vassar and additional criteria we determined during the process. It has an operating width of six feet, a four link system for floatation, an 8 inch drum, Diller-designed teeth, manual angle adjustment, and is hydraulically powered. These were the critical design aspects of the project.

We chose to use an 8 inch drum in order to get adequate penetration and complete break-up of the soil. Many competitors use carbide teeth, but we only use a steel tooth. This tooth, longer than many, allows deeper tillage and better results in unbroken ground. The teeth that we used are made from one inch plate, and can be made from scrap for greater material use efficiency and cost control. They were cut out using a plasma torch and then welded onto the drum in a staggered pattern for more even tillage. Figure 9 shows the assembled 8 inch drum and the tooth layout.



Figure 9. 8 inch drum and teeth



A four link system was integrated to the design to allow the attachment to float. This float allows the attachment to keep an even depth and adjust to any extremely uneven areas encountered. Figure 2 shows the four link system.



Figure 10. Four link system

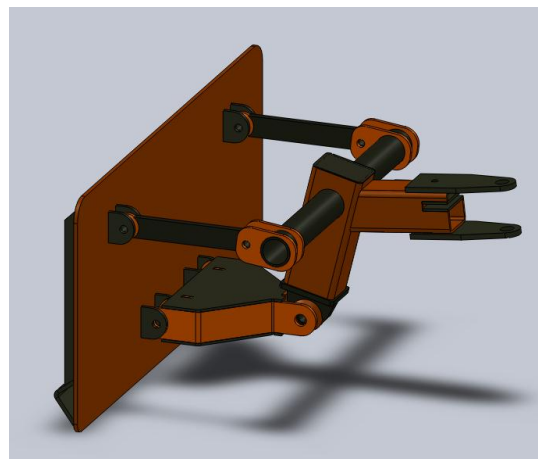

Figure 11. 3-D flotation model

The hydraulic motor used on this design was a gerotor motor. Due to the difficulties in finding horsepower requirements, we selected a motor that Vassar uses on similar sized attachments. Figure 3 shows the hydraulic motor that is powering our attachment.



Figure 12. Hydraulic motor

The manual angle adjustment that we used is a 3/8 inch plate with holes on a radius. This allows the attachment to be pinned at various angles in 7.5 degree increments up to 30 degrees in each direction, and allows the material to be windrowed. Figure 13 shows the manual angle adjustment.



Figure 13. Angle adjustment

## Prototype Testing

Prototype testing was a success. The attachment performed well under the different conditions we tested. A grassy field can be ready for sod laying, sprigging, or seeding after two passes: an initial pass and a back pass. Below is a picture of the finished test field.



Figure 14. Test field, three passes wide

Some modifications were made in the middle of testing to improve the amount of possible floatation. The top links were extended two inches making the center-center distance of the links 12 inches. Extending these parts increased the angle between the upright portion of the frame and the bump-stop which is located at the bottom of the 3-link system. The bump stop is hit when the 3-link bars are parallel.



Figure 15. Modified prototype

We also found that the teeth did not have a perfect cutting pattern. This could have been attributed to both human error in production and also improper alignment in the 3-D model. Below is a picture of the soil profile of tooth depth. It shows that there are spots where there are not teeth on the drum.



Figure 16. Tooth profile in soil

## **Recommendations**

During testing and production of the attachment, we found a few minor details that should be addressed before going into mass production. The first of these is that the angle between the upright and extension tubes of the frame should be increased to make the main beam parallel to the ground and the side plates perpendicular, for ideal soil contact.

Manufacturability is an important consideration for Vassar, and thus we looked for opportunities to improve the design as we assembled it. For instance, we changed from a stub shaft to a solid shaft in the drum. This change raises parts cost, but decreases labor as it is easier to do. The bulkheads were also extremely hard to align and keep in place during welding.

The quick attach plate, standard on most Vassar skid steer attachments, sits close to the ground and in this case interferes with optimal performance. The soil conditioner is designed to be operated with the skid steer arms completely down for ease of operation. Future modifications should keep this in mind. Finally the hydraulic motor could stand to have a slightly longer shaft so that it extends past the edge of the sprocket.

## **Engineering Specifications**

---

Diller Designs attempted to calculate the forces needed to shear the soil during the design of the prototype. In order to solve for the hydraulic horsepower required to drive the drum, we needed to know the relationship between the forward velocity and the rotational speed of the drum, the area in contact with the soil, and several variables related to the soil. Our extensive research in cooperation with BAE faculty through engineering textbooks, journals, and other documents led us to a book that includes the full formula for calculating horsepower necessary for soil breakup:

$$N = N_e + N_d + (1 - \eta)(N_e + N_d) + \frac{v}{75}(\mu Q_z - R_x),$$

$\mu$ = rolling coefficient of the support wheels

$\eta$ = efficiency of the drive

$Q_z$  = vertical load on the support wheels

However, the same text that provides the formula also admits that there are too many variables that can't be calculated. The range of soil conditions and structures makes finding discrete coefficients impossible to determine. (Refer to Technical Engineering Literature in the appendix).

To estimate a hydraulic motor displacement, the competitor's models were looked at to get a starting point for the displacement. A 12.5 in<sup>3</sup>/rev motor was chosen based off of the Harley rake and being that Vassar uses this exact motor on other applications. Using the hydraulic specifications of a CAT 262C skid steer (standard flow), the 12.5 in<sup>3</sup>/rev hydraulic motor output a torque of 6170 in-lbs. and 28 HP at 288 RPM.

The bearings used for the rotating drum is a common bearing that Vassar keeps in stock for their tandem disks. Since it is hard to tell what forces will be acting on the drum, we decided to use a bearing that is already used in a similar way. This bearing has a 1.50" diameter bore, is triple sealed to keep contaminants out, and rated to withstand a 26,200 N force in the radial direction.

## **Environmental, Societal, and Global Impacts**

---

The Vassar soil conditioner is entering an already populated market, so its marginal impact on society, the environment, or globally is small. It does not have enough influence to

have a global effect. All soil conditioners, however, affect the environment and society. Anything that disturbs soil contributes to particle detachment and soil loss via wind or rain. Furthermore, activities that involve a soil conditioner usually have a large effect on the environment, whether in terms of new building construction or new landscaping installation. On the other hand, these same activities are related to economic development, so use of a soil conditioner is a good indicator for the economy.

## **Proposed Media Communications Plan**

---

Finding the best way to market, advertise and represent a product is sometimes a challenge. Each industry consists of different environments, and we should address the needs of each of our target markets. In this project, Vassar is targeting landscape contractors and construction managers who need the ground manipulated as an important step of a job. The communications plan is specifically directed towards these customers, focusing on their conferences and conventions, most visited stores and preferred media outlets.

Landscapers often buy products from mower businesses such as P&K Equipment in Stillwater, Okla. and B&S Lawn and Luber Brothers, Inc. of Oklahoma City, Okla. Businesses such as these are excellent locations to distribute brochures and post flyers about Vassar's new product. Half-page advertisements about the soil conditioner can reach the target audience through placement in the trade publications discussed earlier.

Landscapers have a number of professional societies, including the American Landscape Contractors Association, PLANET (Professional Landcare Network) and the American Nursery and Landscape Association. These organizations provide current industry news to all members. Sending information to these associations enables The Vassar Company to reach contractors across the nation about new product lines and equipment.

These professional societies also host landscapers' conventions for their members to become more acquainted with new products and techniques. The Texas Nursery and Landscape Association, for instance, conducts an annual nursery and landscape exposition in August to educate landscape professionals and the general public alike. The 2011 conference is in Dallas, August 18-21; Houston will host the conference August 17-19, 2012. Surrounding states have landscapers' associations with annual conferences and trade shows as well, a full listing of which is in Appendix 5.

To help The Vassar Company take advantage of these opportunities to promote the soil conditioner, Diller Designs has incorporated pictures and video – with customer testimony, eventually – into a booth to set up and demonstrate during these conventions and expos. Special additions to Vassar's current booth collection include a vinyl sign announcing the new product, informational and instructional literature, and before/after pictures of various sites treated with the soil conditioner. Displaying the product in conjunction with pictures and video showing how the soil conditioner works and in what type of conditions it best performs, will offer additional opportunities for The Vassar Company to sell their product. Since the majority of Vassar equipment is sold via distributors, a full set of brochures, signs, displays, and other informational items will be designed for the dealers specifically, for them to easily add to their trade show materials.

A website page for the soil conditioner has been designed to correspond with the existing company website - [VassarFarmEquip.com](http://VassarFarmEquip.com). This assists the consumer in understanding what the product does, by providing quality pictures and video to demonstrate the implement's capabilities. The Internet is also home to a free source of marketing: industry forums. As mentioned earlier, forums provide a place for industry players to communicate about issues,



techniques, and equipment. It would be beneficial to Vassar's product marketing to establish a presence on forums as a reputable, reliable manufacturer and to get positive attention by users of the Vassar soil conditioner. The relationships built with distributors should result in similar customer relationships, which will generate that positive publicity.

## **Sales Objectives**

---

The meshing of marketing and economics is the sales objectives. For the introductory year, each of Vassar's five domestic distributors will receive five soil conditioners. Customer response to these initial five will determine the quantity and frequency of restocking through each distributor. Long term, Vassar will also seek more dealers in areas that have the largest positive response to the product.

Market introduction is important to the long-term success of a product. Diller Designs is recommending a four month, multi-step approach to product introduction. Introduction to the construction and landscape markets can be done separately, thanks to the differences in the industries. Soil conditioners should be in landscape dealers in early fall or early spring, in time for sod-laying season while construction is pretty consistent throughout the year. Spreading product introduction over many months will ease demands on Vassar's concise staff.

In month 1, Vassar will send promotional material to dealers for display, to begin generating interest. As with other Vassar products, the emphasis should be on the value of the machine for the cost. In month 2, one model will be personally delivered to each selected dealer and completely demonstrated and explained. This initial model can be used for display in the dealer's store to further create interest. If desired, dealers can host a public event to include potential customers in the demonstration. In month 3, repair, maintenance, and use will be further described to the dealers. After this final meeting, another four models will be delivered,

and salespeople can begin selling the product. Customer response in the first four months of introduction, and sales after the product arrives, will dictate how many units each regional distributor will receive and how often.

## **Proposed Business Plan**

---

The soil conditioner designed by Diller Designs and manufactured by Vassar has great potential to enter the industry as a profitable addition to the Vassar product line. It can be sold through current dealers to landscape or construction professionals, or take a step closer to the general public through placement at equipment rental yards. One additional opportunity created with the addition of the soil conditioner to the Vassar product line is the potential for a subgroup of products tailored to the landscape industry. A number of Vassar's current products could be rebranded as landscaping equipment, if so desired, including the post-hole digger and drag scraper. The largest factor to consider with this idea is distribution: whether the Vassar Landscape Line should be sold through current dealers (who primarily sell farm equipment), new dealers who specialize in landscaping and/or construction equipment, or entirely from the Vassar headquarters in Perkins. Due to personnel constraints in-house, finding additional dealers near Vassar's current distributors is probably the easiest option.

All of the individual pieces necessary to build the prototype have been compiled into a table along with cost. The major categories of parts are metal (sheet metal, tubing, drum pipe, and expanded metal), hydraulics (motor, hoses, fittings), hardware, and teeth. Per Jack Vassar's advice, labor is estimated at 70% of the parts subtotal. The total cost of production is currently around \$2,300. These parts are assembled into one table – Total Cost of Production in Appendix 6.

Although this table could have been very useful during design development, engineering constraints were more binding than financial. For future product development, though, this table could still be a useful tool. In its Excel spreadsheet, the table includes a reference to manufacturer's suggested retail price, distributor/wholesale cost, and company margin. These variables can also be modified if the business environment changes.

Diller Designs and Vassar considered the relationship of price and cost, and decided to derive a maximum cost of production from a suggested retail price. Vassar indicated early in project development that they want to be priced in the lower half of the market, similar to their other products' positions in their respective markets. This price is estimated to be \$6,500. Currently, the distributors receive a 40% discount, so the product will have a wholesale price near \$3800. Vassar's goal is to have 22% of production costs as profit, giving a maximum cost to produce of \$3,133. Our cost of production, which includes some estimates, is well under this. Full math is available in the appendix.

## **Bibliography**

---

*ATI Corporation.* (n.d.). Retrieved October 19, 2010, from Preseeder Landscape Tillers:

<http://abcgroff.com/ic/ati1.htm>

*Bobcat Soil conditioner.* (n.d.) Retrieved November 14, 2010 from Bobcat Company:

[www.bobcat.com/attachments/soil\\_conditioner](http://www.bobcat.com/attachments/soil_conditioner)

*Current State of the Economy and Manufacturing.* June 2010. Retrieved October 20, 2010 from

National Association of Manufacturing: <http://www.nam.org>

*FFC Preparator.* (n.d.). Retrieved 2010 19, October, from Preparator:

[http://paladinbrands.com/product\\_detail.aspx?ID=471](http://paladinbrands.com/product_detail.aspx?ID=471)

*Ground Trades Xchange Forum.* Personal communication. Retrieved Nov 9 2010.

*Harley Power Rakes.* (n.d.). Retrieved October 19, 2010, from Power Rakes:

[http://paladinlightconstructiongroup.com/product\\_detail.aspx?ID=492](http://paladinlightconstructiongroup.com/product_detail.aspx?ID=492)

*Industry Report: 23311 - Land Development in the US.* August 2010. Retrieved October 18, 2010

from IBIS World: [www.ibisworld.com](http://www.ibisworld.com)

*Industry Report: 33311 - Tractors and Agricultural Machinery Manufacturing in the US.* July

2010. Retrieved October 18, 2010 from IBIS World: [www.ibisworld.com](http://www.ibisworld.com)

*Industry Report: 42182 - Farm, Lawn, and Garden Equipment Wholesaling in the US.* June 2010.

Retrieved October 18, 2010 from IBIS World: [www.ibisworld.com](http://www.ibisworld.com)

*Industry Report: 44421 - Lawn & Outdoor Equipment Stores in the US.* July 2010. Retrieved

October 18, 2010 from IBIS World: [www.ibisworld.com](http://www.ibisworld.com)

*Industry Report: 56173 - Landscaping Services in the US.* June 2010. Retrieved October 18, 2010

from IBIS World: [www.ibisworld.com](http://www.ibisworld.com)

*John Deere Power Rake.* (n.d.). Retrieved October 19, 2010, from Landscaping Rake Website:

[http://www.deere.com/en\\_US/cfd/construction/deere\\_const/skidsteers/skidsteer\\_attachments/skidsteers\\_powerrake.html](http://www.deere.com/en_US/cfd/construction/deere_const/skidsteers/skidsteer_attachments/skidsteers_powerrake.html)

*John Deere Power Rake Brochure.* (n.d.). Retrieved October 19, 2010, from Power Rake Model

PR60-PR72B-PR84B-PR96B:

[http://www.deere.com/en\\_US/cfd/construction/deere\\_const/media/pdf/attachments/DKA\\_PRCWP.pdf](http://www.deere.com/en_US/cfd/construction/deere_const/media/pdf/attachments/DKA_PRCWP.pdf)

*Meet the Nursery and Landscape Industry.* 2009. Retrieved October 21, 2010, from American

Nursery and Landscape Association:

<http://www.anla.org/index.cfm?area=&page=Content&CategoryID=148>

*Landscaping Services Industry Overview.* (n.d.) Retrieved October 21, 2010, from Hoovers:

<http://www.hoovers.com/industry/landscaping-services/1908-1.html>

*Nortec Piranha.* (n.d.). Retrieved October 19, 2010, from Piranha Power Rakes:

<http://www.nortecmfg.com/literature.php>

*RockHound.* (n.d.). Retrieved October 19, 2010, from RockHound Landscape Rake:

<http://abcgroff.com/ic/rockh1.htm>

*Woods Alitech Power Rake.* (n.d.). Retrieved October 19, 2010, from Power Rake:

[http://www.woodsequipment.com/skidsteerdetail.aspx?id=13579&ekmense1=41a6502d\\_133\\_155\\_13579\\_1](http://www.woodsequipment.com/skidsteerdetail.aspx?id=13579&ekmense1=41a6502d_133_155_13579_1)

*York Landscape Rake.* (n.d.). Retrieved October 19, 2010, from Thee-Point Hitch Power Rake:

<http://abcgroff.com/ic/york3.htm>

# Appendices

---

- Appendix 1 - Introduction to Problem
  - Work Breakdown Structure
  - Task List
- Appendix 2 - Competitive Analysis
  - A) Industry Analysis
    - IBIS World 42182 – Equipment Wholesaling
    - IBIS World 56173 – Landscaping Services
  - B) Customers/Buyers
    - ANLA Website
    - Hoovers
    - Client Phone Conversations
  - C) Client Company and Resources
    - Vassar Product Line
  - D) Selected Competitors
    - FFC Preparator
    - Harley Power Box Rake
    - Nortec Piranha
    - York Landscape Rake
    - ATI Preseeder Landscape Tiller
    - Stone Dawg Landscape Rake
    - RockHound Landscape Rake
    - Erskine Landscape Rake
    - Bobcat Soil Conditioner
    - John Deere Power Rake
  - E) Standards and Patents
    - Standards: SAE J2513
    - Patents (chronological):
      - 7,117,951
      - 0,132,690
      - 6,497,294
      - 6,223,828
      - 5,564,506
      - 5,261,218
      - 4,516,639
      - 3,071,197
      - 3,055,439
- Appendix 3 - Design Aspects
  - Physical Testing Budget
  - Price Estimates from OCT Equipment, Oklahoma City
- Appendix 4 – Spring Project Schedule
  - Gantt Chart
- Appendix 5 – Proposed Communications Plan
  - Landscape Associations, Conferences, and Trade Shows
- Appendix 6 – Proposed Business Plan
  - Costs of Production Table
  - COP Tables

# Soil Conditioner Proposal

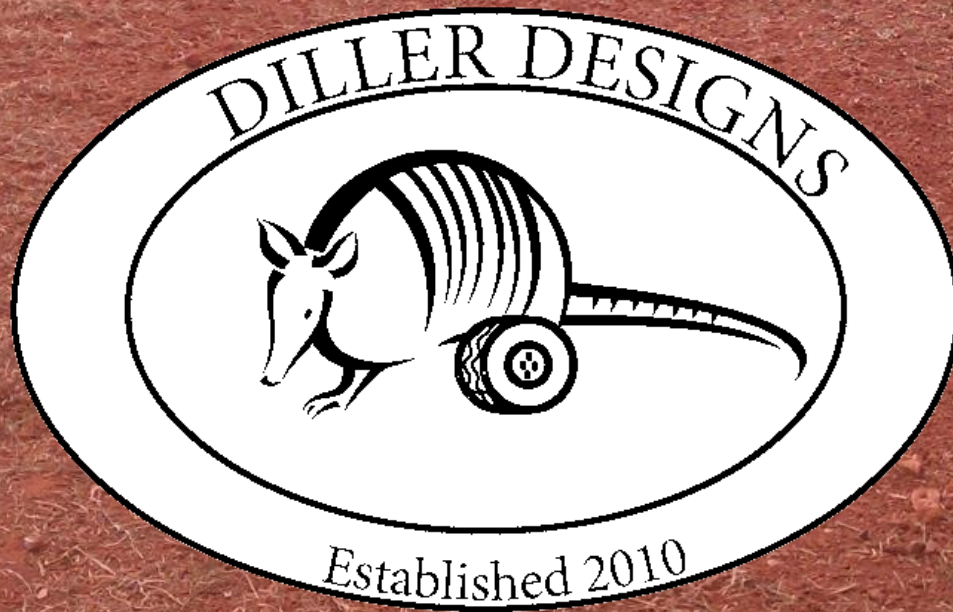

# The Team



Jared Kinder, Paula Smithheisler  
Jacob Huff, Jace Reed, Colin Lowe

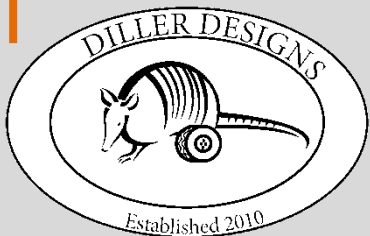



# The Sponsor

## The Vassar Company

- Perkins, Oklahoma
- Established in 1940
- Produces farm equipment
- 6 Distributors including one in Canada distributor

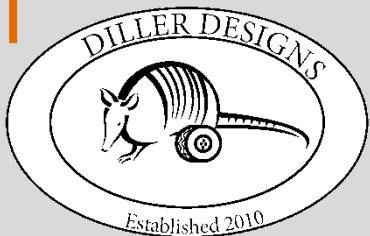
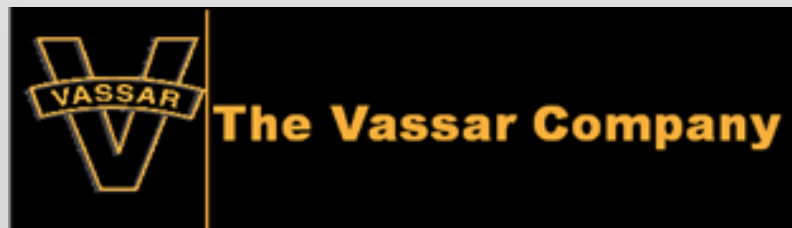

# Product Description

- Design a multi-purpose tool for soil conditioning and seedbed preparation that is innovative, but comparable in features and quality to the competition.
- Soil conditioners are used in soil preparation for landscape designers, sod layers, golf turf managers, construction workers and large acre homeowners.

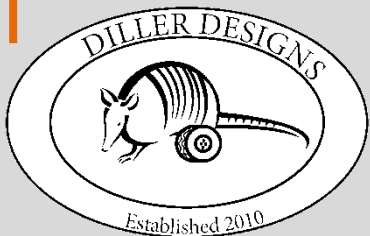

# Industry Analysis

Users of this product come primarily from two markets:

- Landscaping Services
- Construction

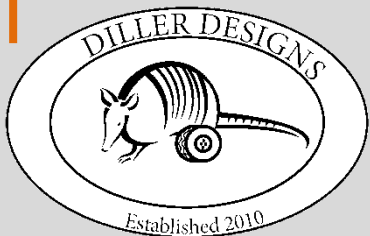

# Landscaping Industry

- Growing industry: easy entry, low start-up costs, large profit potential
- Demand follows national economy
- Equal number of small and large firms:

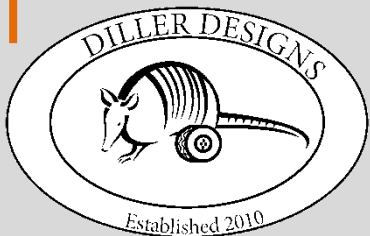
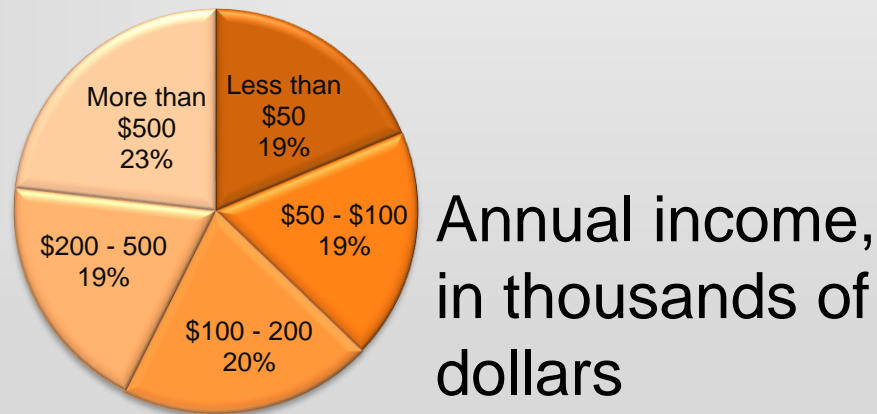

# Construction Industry

- Growing industry: Demand follows national economy
- Single-family homebuilders (86.4% of residential industry) still competitive
- Land developing is projected to increase 9% annually 2011-2015

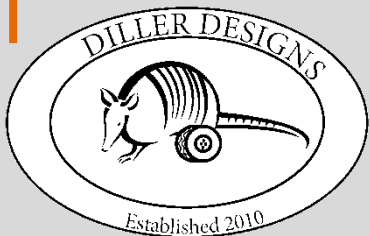

# Specifications

- Size
  - 6ft Working Width
- Hydraulically Powered
- Low Cost
- Durable
  - Over Built

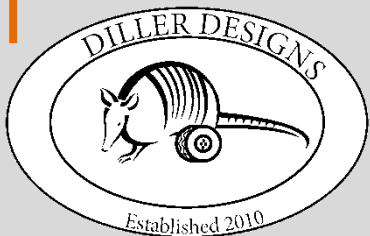

# The Competition

- Harley Power Box Rake
- FFC Preparator
- York Power Rake
- Bobcat Soil Conditioner
- Quick Attach Soil Conditioner
- Stone Dawg



# The Competition

|               | Vassar  | FFC Preparator | Harley  | Stone Dawg | York                        | Bobcat              | Quick Attach        |
|---------------|---------|----------------|---|------------|-----------------------------|---------------------|---------------------|
| Width         | 6'      | 6.5'           | 6'  | 6'         | 6'                          | 6'                  | 6'                  |
| Weight (lbs)  | 870     | 1465           | 900   | 1250       | 952                         | 1100                | 1275                |
| Angle         | manual  | none           | fixed, manual or hydraulic                    | none       | manual or hydraulic         | manual or hydraulic | manual or hydraulic |
| No. teeth     | 76      | 300            | n/a   | 252        | n/a                         | 121                 | n/a                 |
| Type of teeth | spike   | blade          | nub   | blade      | spike                       | nub                 | nub                 |
| Cost          | \$6,500 | \$9,099        | \$7,137 fixed;<br>\$7,876 man;<br>\$8,663 hyd | \$8,995    | \$7,710 man;<br>\$8,655 hyd | n/a                 | \$6,995             |

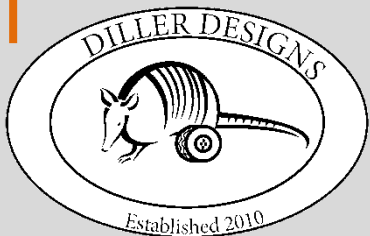



# Testing

## Harley Rake



## FFC Preparator

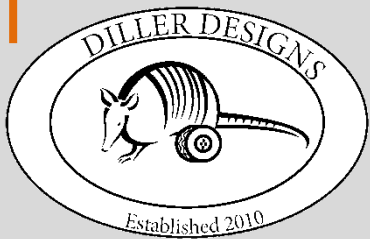

# Fall Design

- Floating attachment
- Direct Drive to Drum
- Bi-directional Hydraulic Motor
- Manual Angle

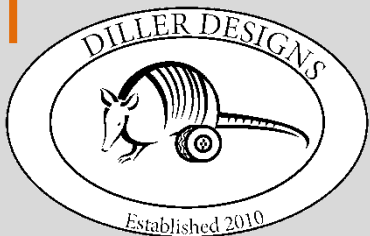
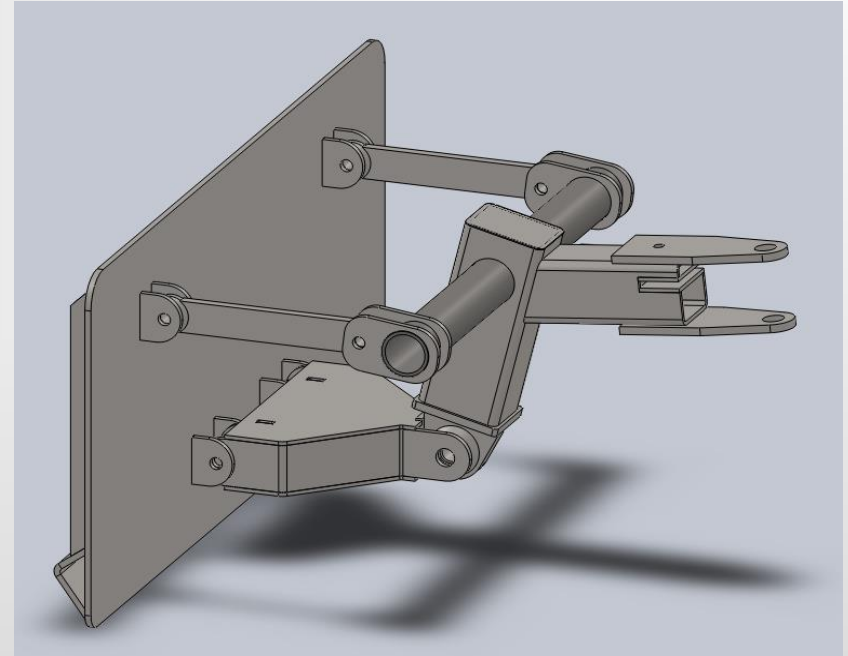

# Design Concepts

## Tooth design

- Number of teeth
- Position/pattern
- Shape/size of tooth

## Drum diameter

- Bearing
- Depth



# Tooth Design Changes

- Teeth number/pattern

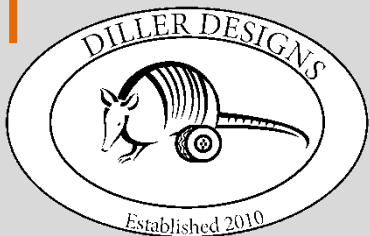
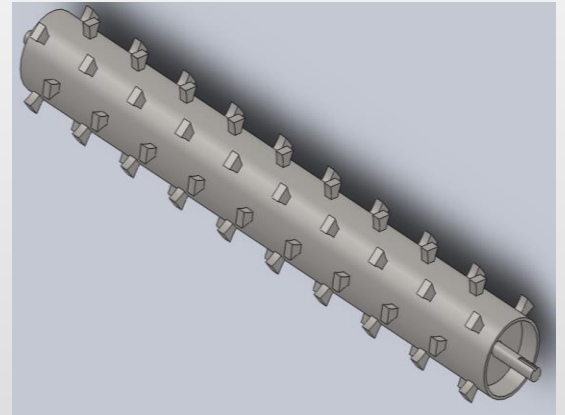
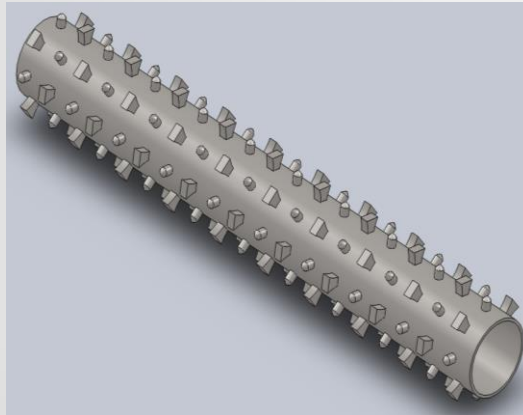
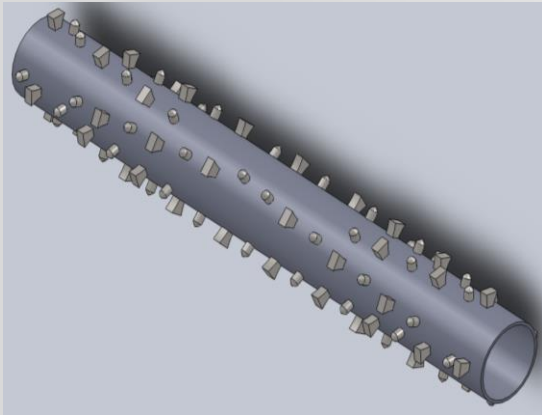

# Float Design

- Eliminates need for multiple adjustments by only using the tilt
- Self-adjusts to un-level terrain

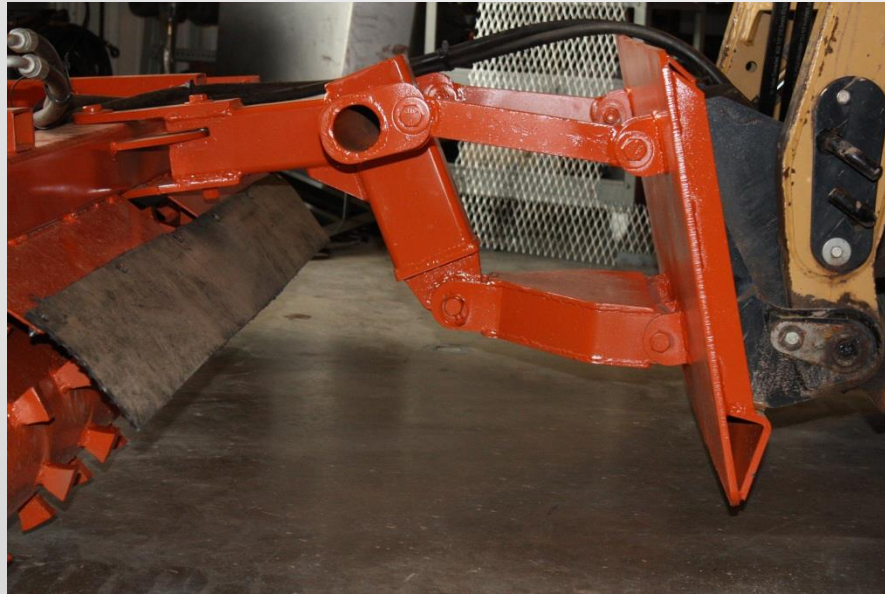

# Hydraulic Horsepower

- The required HP is theoretical
  - Trial and Error
- $$N = N_e + N_d + (1 - \eta)(N_e + N_d) + \frac{v}{75} (\mu Q_z - R_x)$$
  - $\mu$  = rolling coefficient of the support wheels
  - $\eta$  = efficiency of the drive
  - $Q_z$  = vertical load on the support wheels

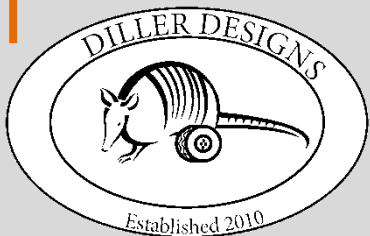

# Drive Design

- Direct Drive
  - Alignment
  - Confined Spaces
- Chain drive
  - Serviceability
  - Manufacturability
  - Motor Placement

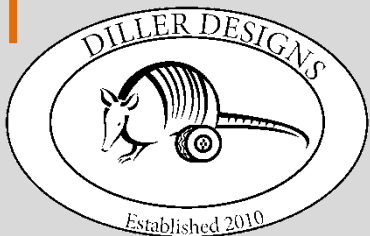

# Safety

- Chain guard
- Shields

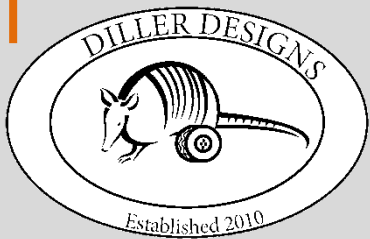



# Production

- Manufacturability
  - Plasma table/Band saw
  - Two Machined Parts
- Problem Area
  - Bulkheads

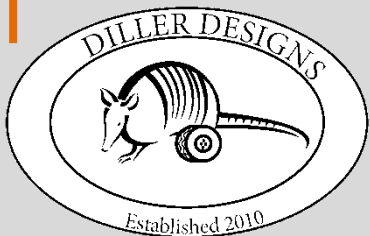

# Testing

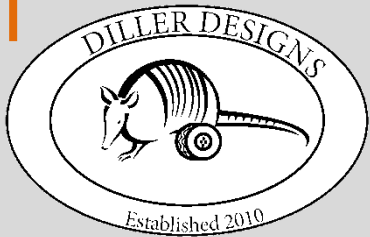
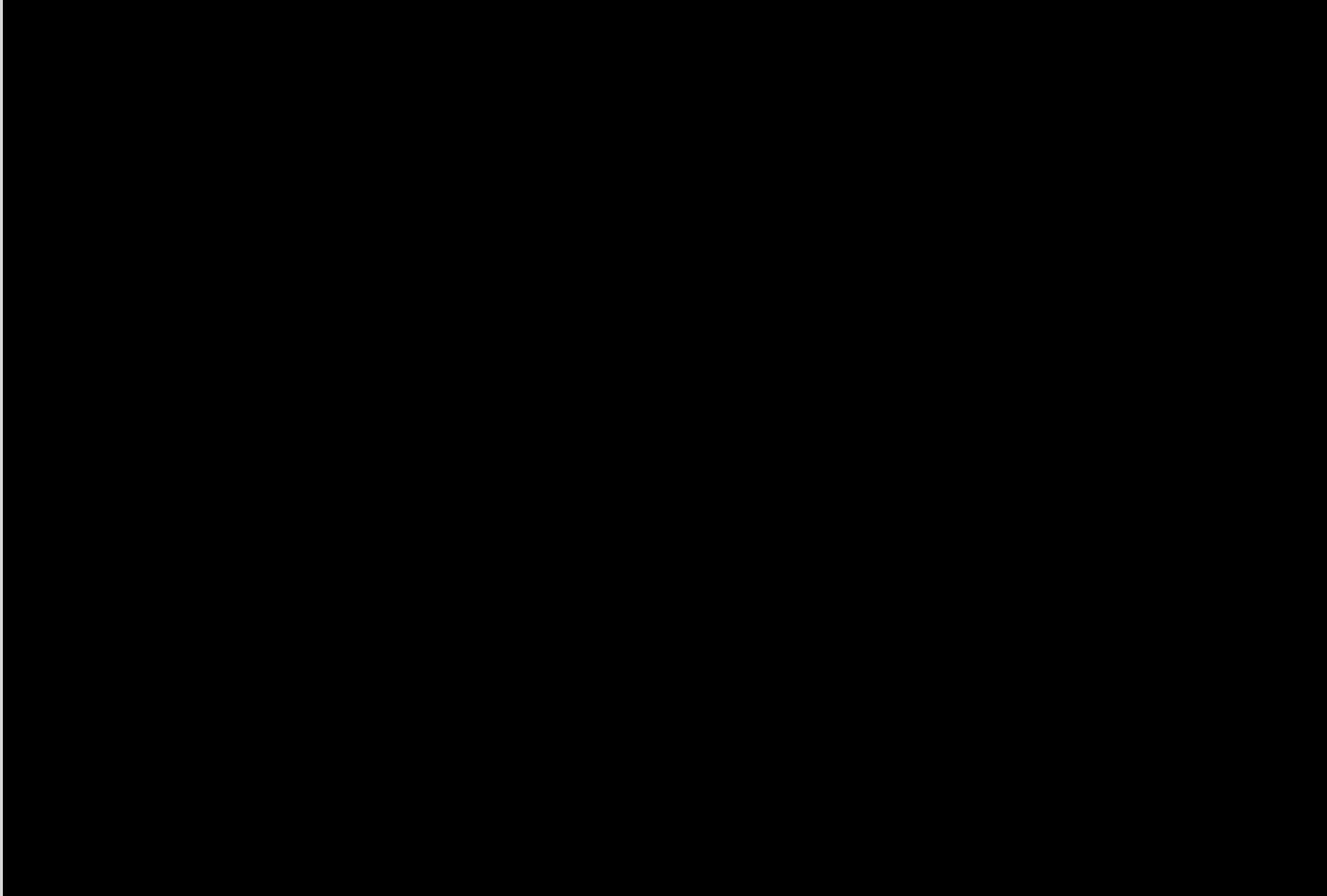

# Modifications

- Lengthened top-links from 10 to 12 inches









CATERPILLAR



# Communication Plan

- Advertisements at Related Businesses
  - Brochures, flyers, etc
- State Landscape Associations
  - Magazine or newsletter ads
  - Conference/trade show displays
  - Assist dealers with displays

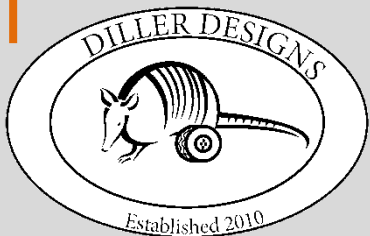



# Trade Shows

- The landscaping industry holds annual trade shows nationwide
- The Vassar Company booth will include:
  - Vinyl signs
  - Implement
  - An iPad
  - Door prizes to reward the customer



# Website

## The Vassar Company

- Home
- About Us
- The Vassar Company
- Fall Report
- Spring Report
- Photos
- Demonstration Video



### Welcome

Thank you for viewing the Soil Conditioner presented by [The Vassar Company](#). This product was designed by Diller Designs, a senior design team from [Oklahoma State University](#).

We look forward to making you an offer on an implement you cannot refuse. Vassar's products offer dependable, long-lasting durability which will last for years to come.

### The Soil Conditioner

The soil conditioner is parallel to the rest of Vassar's products: durable, long-lasting and rugged. This site will help you review the soil conditioner and how it will become a valuable asset to you and your company.

If you have any questions, please feel free to contact us.

405-555-5555 • 123 Diller Design Rd. • Stillwater, OK • 74075



# Business Plan

- Product/brand diversification
- Introduction Schedule
- Pricing target
  - MSRP Goal: \$6500
- Price-driven costs
  - Production table



# Production Table

|                        |                |
|------------------------|----------------|
| Metal                  | \$302          |
| Steel plate            |                |
| Drum                   |                |
| Tubing                 |                |
| Expanded metal         |                |
| Hydraulics             | \$606          |
| Motor                  |                |
| Hoses                  |                |
| Fittings               |                |
| Hardware               | \$450          |
| Teeth                  | \$21           |
| Parts Subtotal         | <u>\$1,379</u> |
| Labor                  | 0.7            |
| Production Grand Total | <u>\$2,344</u> |

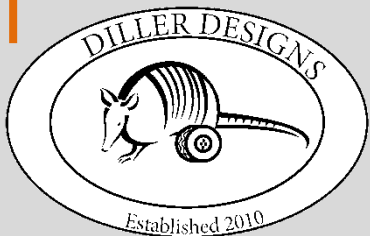

# Other Expenses

- Trade show space
- Vassar promotional materials
  - Shared between all Vassar products
- Vinyl signs
- Soil conditioner promotional material
- User manual

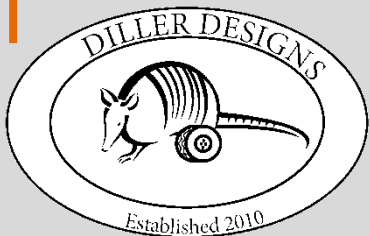



**The Vassar Company**

Diller Designs

Oklahoma State University

111 Ag Hall

Stillwater, OK 74078

Phone (405) 706-7165

Fax (405) 744-6059

E-mail:

[jacob.huff@okstate.edu](mailto:jacob.huff@okstate.edu)

The Vassar Company

P.O. Box 609

Perkins, OK 74059

Phone (405) 547-2454

Toll Free (877) 229-8049

Fax (405) 547-2929

E-mail:

[vassar\\_co@vassarfarmequip.com](mailto:vassar_co@vassarfarmequip.com)



## Design of a Soil Conditioner

Jacob Huff  
Jared Kinder  
Colin Lowe  
Jace Reed  
Paula Smithheisler

2010 Fall Design Report

Prepared for TheVassar Company

---

## Table of Contents

|  |    |
|--|----|
| Introduction to Problem .....                                      | 1  |
| Problem Statement .....  | 1  |
| Statement of Work .....  | 1  |
| Background .....   | 1  |
| Scope of Work .....  | 2  |
| Location of Work .....   | 2  |
| Period of Performance .....  | 2  |
| Delivery Requirements .....  | 3  |
| Acceptance Criteria .....  | 3  |
| Special Requirements .....   | 3  |
| Work Breakdown Structure Task List .....                           | 3  |
| Competitive Analysis .....   | 4  |
| Industry Analysis .....  | 4  |
| Customers/Buyers .....   | 8  |
| Client Company/Agency and Its Resources .....                      | 11 |
| Selected Competitor Review .....                                   | 13 |
| Patent Searches .....  | 15 |
| Relevant Standards .....   | 16 |
| Design Aspects .....   | 15 |
| Lab/Field Experiments and Physical Testing & Data Collection ..... | 15 |
| Design Concepts .....  | 18 |
| Engineering Specifications .....                                   | 19 |
| Project Schedule .....   | 19 |
| Proposed Budget .....  | 20 |
| Proposed Media Communications Plan .....                           | 20 |
| Proposed Business Plan .....                                       | 22 |
| Bibliography .....   | 24 |
| Appendix .....   | ii |

---



## **Introduction to Problem**

---

The Vassar Company, located in Perkins, Okla., is an equipment manufacturer for the farm and small-scale construction industries. A number of their products are versatile enough to be used by landscapers and acreage owners, and for agricultural and industrial purposes. They rely on a team of salespeople throughout the Southeast and a network of dealers around the country for product distribution. The company was founded in 1940 by I.D. “Jack” Vassar, and is managed today by Jack’s son and granddaughter, Jack K. and Jacque Vassar. The Vassar Company is known for their well-crafted equipment, and is looking to expand into other markets.

### **Problem Statement**

Diller Designs is tackling a challenge for the landscape industry. The Vassar Company (Vassar) has assigned us the task of designing a powered multi-purpose implement for soil conditioning and seedbed preparation. The design will be innovative, but comparable in features and quality to the competition, while priced to sell to the landscape contractors and small construction companies.

### **Statement of Work**

#### **Background**

The Vassar Company will be presented a soil conditioner skid steer attachment to compete with other competitors’ product lines. Soil conditioners are used in soil preparation for landscape designers, sod layers, golf turf managers, construction workers and large acre homeowners. Current models specialize in soil tillage, rock and debris collection, and/or soil finishing. Vassar’s model will combine the tillage and soil finishing attributes.

## **Scope of Work**

- Diller Designs will submit a design proposal at the end of the fall 2010 semester that

includes:

- Team Overview
- Project Overview
- Competitive Analysis
- Budget
- Experiment Data
- Engineering and Design Concepts
- Proposed Communication Plan
- Proposed Business Plan

• At the end of the 2010 spring semester, Diller Designs will submit a working prototype and final report which will include engineering and technical specifications, a product plan, an enterprise budget and a comprehensive marketing plan.

## **Location of Work**

Diller Designs will complete product analysis experiments at the Cowboy Motorsports test track. Design development will be completed in the BAE computer lab. Fabrication of the product will be conducted at both the BAE Lab and Vassar's manufacturing facilities.

## **Period of Performance**

August 2010- April 2011

## Delivery Schedule

| Deliverable              | Due Date |
|--------------------------|----------|
| Team Leader              | Sep 15   |
| Team Name                | Sep 17   |
| Logo                     | Sep 17   |
| Problem Statement        | Oct 8    |
| Mission Statement        | Oct 8    |
| Test Plans               | Oct 15   |
| Competitive Analysis     | Oct 22   |
| Statement of Work        | Oct 29   |
| Work Breakdown Structure | Nov 1    |
| Final Report             | Dec 9    |
| Final Presentation       | Dec 9    |

## Acceptance Criteria

Acceptance will be contingent on the final design and prototype. Vassar has given us specific criteria for the implement. The implement should not limit itself to one function, unlike competitors' models that only smooth, rake, or pick up rocks. The implement has size requirements, described in detail below. The quality of design and workmanship must also correlate with Vassar's reputation for rugged reliability.

## Special Requirements

Diller Designs has parameters to follow during the design process. Vassar would like to produce an implement 6 feet in width (compatible with an average skid steer) which can be manufactured using as many parts from the current inventory as possible. The implement will have a quick-attach hitch to connect to a skid steer using the industry standard, ISO 24410:2005.

## Work Breakdown Structure Task List

Our work breakdown structure is a graphical organization of the tasks necessary to complete the engineering, economic and communications project development. The full

breakdown of tasks for the initiation, planning, design, implementation, management, and closing of the project is in Appendix 1.

## **Competitive Analysis**

---

Customers choose this product when it is time to prepare an area of soil for building construction or for landscaping installation. A soil conditioner similar to the observed designs can be used for soil preparation or as a finishing tool. As a soil preparation tool, it will clear grass, rocks, and debris from the site, break up the top layer of soil, fluff, smooth, and level the soil. It can also be used prior to grass seeding to create an ideal seedbed. As a finishing tool, it smoothes and levels the soil, clearing debris away.

## **Industry Analysis**

This project is mainly influenced by two distinct industries: equipment manufacturing, as a product of Vassar, and landscaping, which will use Vassar's product. The project is also influenced by the construction industry, which has some use for this machine.

The IBIS World report for the landscaping services industry indicates easy entry, low start-up costs, and potential for large profits for individual firms, as well as steady performance over the last few years for the industry as a whole (but expected to take off in 2011 with national economic recovery). The entire industry is expected to earn \$50.7 billion in 2010 (4.7% real decline from last year) with 25.8% coming from the design and build segment (where this product would fit). Industry results are tied to the national economy. Since consumers (both residential and corporate) view landscaping service as a luxury item, this is one of the first expenses to be cut in tight economic times and one of first reinstated when customers' financial situations improve. Landscaping has low barriers to entry compared to the profit potential, so the

number of landscaping companies (potential customers of Vassar soil conditioner) is projected to increase in the next five years. Also, new home building increases with economic stability, which benefits both landscape and construction companies. Income of the more than 260,000 landscape companies is almost evenly divided across firm size, as shown:

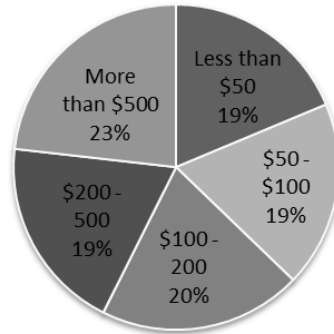

Figure 1. Annual Income in thousands of United States Landscapers

This even distribution suggests there is no concentration of firm size, and also that the landscaping industry does not have a small number of highly influential firms – most landscapers cover a small geographic area (IBIS World 56173, 4-17). It should be noted that Vassar will market the conditioner to both small and large firms.

Another important industry highlighted on IBIS World is Farm, Lawn, and Garden Equipment Wholesaling. This is the closest category for Vassar, as none of the other manufacturing industries incorporates this product. According to the IBIS report, lawn and garden equipment sales have been suffering with the economic situation, like the landscaping industry. The report predicts steady sales for the rest of 2010, but accelerating revenues in 2011 with increased sales to the housing market and the aging population that will soon have time in retirement to return to yard work (IBIS World 42182, 6-16). Retired homeowners are not

targeted customers of soil conditioners, but their interest in gardening or outdoor entertaining could encourage use of landscapers to prepare yards. The report also suggests that equipment rental companies will become a larger customer base for lawn equipment (IBIS World 42182, 17).

IBIS World reports on a number of related industries, all affected with the economy. Land & Outdoor Equipment Retail – referring to the specialized stores – for instance is experiencing a price-driven market, thanks to greater competition from Wal-Mart and home supply stores as homeowners are looking for less expensive products. Due to this shift in consumer purchases (and subsequent effects of consumers' tendency to maintain their habits as long as the product quality is similar), this industry is declining overall (IBIS World 44421). Luckily, this is not the targeted market for this product. Land development is expected to increase with the economic recovery as developers become more confident about building homes and offices (IBIS World 23311). The industry report for Tractors & Agricultural Machinery predicts a strong global demand from agricultural success (IBIS World 33311). This also does not directly affect this project, but success may affect manufacturing decisions of those companies that produce both agricultural and landscaping equipment, changing the competitor dynamic.

Overall, the project's economic outlook has a positive relationship to the economic conditions of the United States, as customers' demand for landscapers is related to their disposable income and time to do yard work themselves (IBIS World 56173, 12). The manufacturing of the conditioner will follow trends in the manufacturing industries, but the economic outlooks of its target industries' markets – construction and landscaping – are important to our marketing plans.

Governmental and industry regulations for the most part do not affect this product. Phase II of the National Pollutant Discharge Elimination System (concerning pollution via runoff) could be significant, if the job site in question is over an acre in size. Landscapers are also subject, like other employers, to labor laws and immigration issues. Other major concerns for the landscaping industry – engine emissions and pesticide use – are less important to this particular product.

Pertinent industry standards relate to the attachment of the implement to the skid steer. The attachment standard (ISO 24410:2005) is discussed in greater detail later. Design standards do not exist for soil conditioners.

There are many trade publications applicable to these industries. Landscapers have the choice of Landscape Management, Lawn & Landscape, Green Industry Pro, Turf, and Total Landscape Care. Applicable sources, articles, or advertisements can be found in Commercial Dealer, Compact Equipment, and Equipment World. A thorough inspection of the Edmon Low Library at Oklahoma State University found issues of a few of these magazines: Landscape Management, Landscape Architecture, Equipment Dealer, and a number of horticulture magazines. Other than an article on the “Top 150 Contractors” in the June 2010 issue of Landscape Management and a directory of equipment manufacturers published by Equipment Dealer, the search at the library did not contribute to our research.

IBIS Worlds states 19.3 percent of landscape companies have up to two employees, 21.7 percent have three to four employees and 28.2 percent have between five and nine. This small scale, along with the low barriers to entry described earlier, suggest that landscapers operate in a narrow geographic region. These landscapers are members of state and regional industry groups, many of which hold annual conferences and trade shows. Two of the largest nationwide shows

are the GIE+Expo, held in Louisville, Ky., every October and the Landscape Industry Show held in late January or early February in Los Angeles, Calif. A listing of regional associations and their trade shows are in Appendix 6.

Diller Designs does not expect physical resources to be limiting to this project. The necessary manufacturing resources are steel and other materials for production, and labor to run the machines and assemble finished products. Users of the product will need a skid steer (which requires fuel and labor to operate) and a job site. The product will be applied to new construction sites or to residential lawns, neither of which will be limiting nationwide.

### **Customers/Buyers**

The IBIS Report on Landscaping Services indicates landscape customers are driven by price, causing contractors to be sensitive to operating costs in order to stay competitive (IBIS World 56173, 4). At the same time, landscapers have to be sensitive to quality of their equipment, because breakdowns and design mishaps delay jobs and therefore profits.

Page 4 of IBIS World 56173 also says the following:

“The perception that landscaping services is a luxury and discretionary service means that in harsh economic conditions, client expenditure is reduced and price-based competition rises in intensity.”

The economic times of those who are still buying services have contributed to the price-driven market. New construction is also slow during an uncertain economy. The market for this product may not be looking to invest in new equipment at the moment, but landscaping and construction will pick up again when the economy recovers, recharging demand for this product. According to the American Nursery and Landscape Association, an average of 85 million



households take part in lawn and garden activities (ANLA);the market for individual customers of Vassar’s product is a subset of this number.

Vassar follows a business-to-business marketing structure, as most output is sold to dealers. In this case, the dealers will sell to landscapers or construction companies, or to the equipment rental companies that serve these final customers. Many competing manufacturers (Harley, FFC, John Deere, Caterpillar, and Nortec, for example)also market their products this way, as seen in their websites: they advertise their models and give lots of information and details, but refer interested parties to a nationwide network of dealers. Some companies, including York, include a phone number for customers to call and buy direct from the manufacturer to avoid the middle man.

It is difficult to find exact demographics of Vassar’s market, because landscapers can be classified in a number of areas in the U.S. Census, from service to groundskeeper/grounds maintenance to agriculture. Many reports classify landscape services as agriculture, but searches for agricultural reports find more results from crop and livestock production than landscaping. It is known that firms employ a variety of races (Hoovers), but demographics by specific occupation are not accessible online. Landscapers’ primary customers are businesses and middle-to-upper class households (IBIS World 56173) and that’s as precise demographics for the final customers as we can discern.

The economic status of individual industries can also be difficult. For Vassar’s specific industry – manufacturing – reports come out regularly updating industry health. The most recent of these, retrieved from the National Association of Manufacturers, reflects the economic downturn and the current revival of construction and production. Consumer spending, which is associated with the demand for landscaping services, recovered from a 3.5% decline in the third

quarter of 2008 to a 3.0% growth in the first quarter of 2010. Productivity of manufacturing in the first quarter of 2010 was a 7.5% increase, compared to 2.4% decrease in the first quarter of 2009. Construction spending is increasing at a higher rate than in 2009 (NAM). Together, these numbers suggest a recovery of the industry and the markets.

Market research is accessible for landscaping, but much is proprietary. Further market research will be helpful to identify less common brands, preferences of people who have used all of the many styles of tools – and what style different people associate with different terms. Our preliminary market research used the term ‘landscape power rake’ and we found many differences between regions or persons in interpretation of that term. Due to this, we changed our views of the terminology and refer to it as a “soil conditioner,” which is less ambiguous and more descriptive of the product. Another resource of which Diller Designs has done basic explorations is industry forums, where equipment operators around the country discuss pros and cons of tools or brands for everyone on the Internet to read. Discussions with three landscapers from around the country showed more ambiguity about the product name, but were also informative. One landscaper uses the powered lawn rake model and two use Harley Rakes (one also uses the Woods model). The two relevant responses – from a landscaping company in Massachusetts and one in North Carolina – also indicated skid steers as their primary tool (the North Carolina response indicated many competitors use skid steers as well) ([GroundTradesXchangethread](#)). Other searches of this and similar forums indicate that landscapers both buy and rent equipment.

Primary research was also done via phone calls to landscape contractors in Texas, Oklahoma and Colorado, for variety of geographic location. These phone calls reaffirmed the decision to build for a skid steer rather than a small tractor, but provided little input in design,

because few of the contractors contacted have used a soil conditioner. A full listing of contractors contacted and call summary is in the appendix.

### **Client Company/Agency and Its Resources**

Vassar's management team is very concise and therefore efficient. Jack Vassar is the owner and general manager of The Vassar Company. Jacque Vassar, Jack's daughter, is the assistant general manager and daily overseer of operations in the office. Larry Johnson serves as the plant manager. Pam Graves is the payroll clerk and human resources manager at the office in Perkins, Oklahoma.

Vassar's sales team travels around the Arkansas, Mississippi, Tennessee and Oklahoma areas making contacts with potential dealers. Vassar is a farm equipment manufacturer which sells some equipment from the home location via telephone and website, but also sends products to distributors around the country. These are as follows:

Gearmore, Inc.  
Chino, CA 91710  
909-548-4848

Price Brothers  
Wichita, KS 67202-0124  
316-265-9577

Alliance Distributing  
Hewitt, TX 76643  
800-227-6367

Rankin Equipment  
Yakima, WA 98907-0168  
509-453-8271

Tri-State Distributors  
Statesville, NC 28687  
704-873-0531

Robert Laning & Sons  
Waterford, ON Canada NOE 1Y0  
519-443-8601

All products are made in-house at Vassar. The manufacturing resources are stable, as materials are purchases from steel yards located in Chicago, Illinois; Houston, Texas; Oklahoma City, Oklahoma; Tulsa, Oklahoma; Muskogee, Oklahoma; and St. Louis, Missouri.

The assortment of equipment Vassar manufactures is very diverse. The products range from hay spears to grapple claws and even scrapers. Most of the products fit into the lower pricing segment of the market, but are marketed emphasizing their durability and quality workmanship. Mr. Vassar will add the soil conditioner to this line-up of well-built, affordable equipment. Below is a summary of Vassar’s current product line, as found in Vassar’s product notebook and Appendix 2-C of this report:

Table 1. Current Vassar Products

| Vassar Equipment Product List and Prices |            |
|--|------------|
| Product                                  | Base Price |
| Disc Mower Caddy                         | tbd        |
| Compact Grapple                          | \$1,849    |
| Compact Bucket Grapple                   | \$2,083    |
| Ranch Post Hole Digger                   | \$1,216    |
| Wheel Type Tandem Disc                   | \$5,930    |
| Wheel Type Offset Disc                   | \$7,347    |
| 3-Point Tandem Disc                      | \$2,775    |
| Drag Scraper                             | \$3,179    |
| Arena Groomer                            | \$1,690    |
| Dirt Scoop                               | \$4,140    |

## Selected Competitor Review

Table 2. Major Competing Products

|               | FFC Preparator | Harley  | Stone Dawg | York                        | Bobcat              |
|---------------|----------------|---|------------|-----------------------------|---------------------|
| Width         | 6.5'           | 6'  | 6'         | 6'                          | 6'                  |
| Weight (lbs)  | 1465           | 900   | 1250       | 952                         | 1100                |
| Angle         | none           | fixed, manual or hydraulic                    | none       | manual or hydraulic         | manual or hydraulic |
| No. teeth     | 300            | n/a   | 252        | n/a                         | 141                 |
| Type of teeth | blade          | nub   | blade      | spike                       | nub                 |
| Cost          | \$9,099        | \$7,137 fixed;<br>\$7,876 man;<br>\$8,663 hyd | \$8,995    | \$7,710 man;<br>\$8,655 hyd | n/a                 |

FFC Preparator, Harley Power Box Rake, Stone Dawg, York Rake, and Bobcat Soil Conditioner

Harley Power Box Rakes lead the industry by being the most well-known landscape rake. Harley offers rake attachments for mini skid steers, skid steers and tractors, in widths from 4 to 9 feet. Options like the reversible box ends, dual independently-adjustable gauge wheels, adjustable rock barriers, and carbide teeth provide a product that helps reduce the amount of work required by users (Harley Power Rakes). The success of Harley comes from good marketing through different methods including tutorial videos on YouTube. These are a few of the features which should be taken into account during the design process. Harley's design will be more influential than any of the following products.

The FFC Preparator is sold as a clean-up, rock removal, and soil preparation product (FFC Preparator). It takes the general soil preparation that most landscape rakes offer and adds rock removal. The rocks are collected in the bucket of the device which is fully enclosed. The Preparator comes with three different weight options ranging from 976 to 1650 pounds. The Preparator is listed as being able to pick up rocks from one to twenty inches in diameter. In early design review, the design for this product was favored, until testing of the product, when larger design flaws became apparent. Small holes on top of the machine serve an important purpose, but

we only experienced the soil particle projectile capabilities of them. Furthermore, the machine did not satisfy our performance standards.

Piranha, manufactured by Nortec and not listed in the table, is produced for both 3-point tractors and skid steers. Widths of this machine can range from 3-8 feet. Each model has adjustable gauge wheels, side shields, manual or hydraulic angle control, and multiple rotor options. The Piranha offers a versatile selection, including 16 different models(Nortec Piranha), which should be taken into consideration when we begin to design Vassar's product.

The Rockhound or Stone Dawg is the least competitive of the products we found to be used as a reference during design. The Rockhound picks up rocks from the ground and throws them into the bucket of the skid steer. A chain-link system with rake bars removes the rocks from the soil(RockHound). This design is not desirable on the basis of cost and lack of versatility.

York produces rakes in 6-8 foot models ranging from 923-1020 pounds for 3-point hitch tractors and skid steers. The 3-point rakes can come with power take off (PTO) or hydraulics. The model designed for the skid steer does not have any major options which distinguishes it from the crowd, but does have a simple easy-to-service design (York Landscape Rake).

Bobcat makes a similar skid steer-mounted product, called a soil conditioner, which smoothes ruts, moves material, and levels mounds. Like the Harley Rake, it also comes with adjustable wings to move loose soil and can float along soil topography. The soil conditioner is available in widths between 4 to 7 feet, has manual and hydraulic angle controls, and a high-flow option. Foam-filled tires prevent flats. A locking option on the drum allows the implement to be used as a box blade (Bobcat).

The ATI Preseeder, not listed in the table, has a simple drum rotor that spins counterclockwise just like most other landscape rakes and is advertised to function well in tilling, leveling, and raking/windrowing. There are five available models ranging from 5 to 7 feet and between 780 to 1225 pounds. The rake has an option to rotate 20 degrees in either direction. One option which separates the ATI Preseeder from other rakes is a finisher roller to complete seedbed preparation (ATI Corporation).

## **Design Aspects**

---

### **Patent Searches**

The following patents are the most relevant results from searches of the United States Patent and Trade Office. Full listing of these and additional related patents are in Appendix 2-E.

#### **10,744,308 June 23, 2005**

Granted to: Caterpillar, Inc., Peoria, Ill.

This patent relates to the serviceability of implement teeth. Teeth are welded to bars, which are attached with bolts to drive chains. This patent was integral to early design concepts, but will not be integrated into the current design.

#### **6,497,294 December 24, 2002**

Assigned to: Clark Equipment, Woodcliff, NJ

This patent covers a number of design features of current models. The flip up bolster member/caster wheel adjustment (along with the adjustability of the bolster member), more aggressive drum teeth, the radial crisscrossing pattern of the teeth on the drum, replaceable shell of the drum separate from the drive axle, symmetrical drum pattern so drum can be used in the reverse direction for certain applications, and a radial float assembly (to adapt to changing

directions of the skid steer) are the pertinent features described. It is important for us to know what features we might want to include that are patented, to avoid infringement.

**6,223,828 May 1, 2001**

Assigned to: Caterpillar, Inc., Peoria, Il.

This patent relates hydraulically controlled float capability of implements, allowing them to responsively move to avoid damage to teeth by irregular objects such as large rocks and logs. This patent is interesting because of its innovation, and was pertinent to design ideas when we considered building a model similar to the FFC Preparator, but is not related to our current design.

**5,564,506 October 15, 1996**

Assigned to: Farmers' Factory Company, Rockford, Il.

This patent covers the process of collecting rocks into the bucket and the dumping of the rocks along with the separation of the rocks and dirt. A design integrating a bucket allows for rock picking separate of the conditioner unit allows more flexibility in the product's use. Having functions separate allows each side of the rake to float over uneven ground.

**5,261,218 November 16, 1993**

Assigned to: Great Plains Manufacturing, Inc., Great Plains, Ks.

This patent covers the methods of separation of debris from the soil and the act of windrowing the debris by using adjustable tine height and a powered roller. Although this patent is from 1993, it cites marketing materials from Harley and ATI, giving time perspective to the soil conditioner or power rake market.

**Relevant Standards**

ISO 24410: 2005



This standard sets forth standard dimension requirements for the loader attachment bracket and attachment interface to allow interchangeability of attachments on skid steer loaders whose operating mass is 4,500 kg (9920 lbs) or less. Narrow skid steer loaders may have a width which does not allow compliance with this standard. The design of the loader attachment bracket locking system is not restricted by this standard and is left to the discretion of the manufacturer. It is not applicable to attachment interface brackets connected to the attachment bracket by a lateral locking system.

This standard also supersedes the SAE J2513 standard, which described the same process, and is listed in the appendix instead of the ISO standard, for ease of procurement.

### **Lab/Field Experiments and Physical Testing & Data Collection**

Field testing offered a first-hand understanding of the capabilities and operations of current landscape rakes and soil conditioners. After market research, two current models were chosen to observe – Harley’s Power Box Rake and FFC’s Preparator – on the track of Cowboy Motorsports November 7, 2010. Ditch Witch also offered a prototype developed by their engineers to add to our testing. During testing, different design aspects were considered by the engineering specialists of Diller Designs.

The characteristics observed during field testing were overall performance, maneuverability, ease of service, windrowing and rock collection efficiency, and operating specifications such as tillage depth and aggression. These were measured through observation and collaboration of the team. Vibration was noted by the skid steer operator, as was the amount of headland required for turning. In testing serviceability, we found how accessible inner workings were and determined everything seemed to be easily accessible and identified the

permanent and replaceable parts. These trials, as well as an overall evaluation of performance, were conducted over a variety of terrain, including grass, cleared ground and tilled/loose soil.

The Harley Power Box Rake performed the best of the three. The best features about the Harley were the soil condition after use, ease of maneuverability, and the tooth design. Some disadvantages include slow-to-adjust hydraulic angling, shallower depth of tillage than the other two, and difficulty keeping the machine level over uneven ground.

The FFC Preparator, which we originally planned to use as a starting point, works well at removing debris from the surface, but came with many disadvantages. As mentioned earlier, the machine frequently discharged soil particle projectiles, and the efficient debris removal resulted in the need to dump the bucket often. The brush roller clogged easily in grass and did not give a visible difference in smoothness of bare soil. Finally, the depth of tillage was not satisfactory.

## **Design Concepts**

After competitor testing, Diller Designs determined a soil conditioner similar to the Harley Rake was the best plan of action. However, to have something similar to a “one-pass” machine, there must be some design changes. Longer teeth will be required to achieve the proper tillage depth in ground which has not been previously disturbed. Another change we could make is the addition of two extra gauge wheels to insure accurate depths of tillage by the machine. Using two gauge wheels makes it hard to level. Another option is to use a three-link system in order to allow the machine to float with the contour of the ground. This will still require two fixed wheels on the front but will be mounted using a receiver type attachment. Having this receiver “hitch” will allow us to remove the wheels and put in a rod for laying down sod. The design’s tillage width will be no wider than the average skid steer, approximately 6 feet.

Some additions to landscaping implements which are not currently implemented could be an edger, fertilizer spreader, magnetic bar or possibly a drag harrow brush. Safety issues that will have to be addressed include pinch points during angle changes, gauge wheel adjustments and during attachment of the implement. Another safety issue which will need attention is possible overload in the hydraulic system which could result in user harm. The most important safety aspect will be that of rotating parts on the implement. Any component which includes rotating parts offers potential for injury to the operator.

## **Engineering Specifications**

---

Diller Designs plans on calculating many different engineering specifications in the spring semester of the project. The horsepower available by the skid steer, given an implement width of 6 feet, will determine number and size of teeth. The relation of the velocity to the machine vs. the angular velocity of the drum versus the profile of the soil disturbance should be plotted. A hydraulic system will need to be designed for powering drum rotation. The bearings for the drum will also need to be sized to the shock load of the system.

## **Spring Project Schedule**

---

Our spring tasks include additional technical research, prototype fabrication and testing, completion of the business tasks – economic analysis, product plan, and related documents – and completion of the communications campaign. A full listing of these tasks is provided in the appendix, in Gantt chart form.

## **Project Budget**

---

The Diller Designs expects the following expenses from August 2010 to May 2011:

- Rental for field testing (travel costs)
- Quick attach plate (from Vassar, to insure compatibility)
- Steel for frame
- Drum and hardware
- Hydraulics
- Hitch pins
- Wheel assembly
- Joints
- Machining time
- Advertising materials

The manufacturing costs will all be tabulated, per Proposed Business Plan description, and available in Excel spreadsheet form in Appendix 5.

## **Proposed Media Communications Plan**

---

Finding the best way to market, advertise and represent a product is sometimes a challenge. By completing research pertaining to who the customer is, where they travel and what media they utilize, a customized communication can be created. In this project, Vassar is targeting landscape contractors and construction managers who need the ground manipulated in order to perform the next task they have to complete.

Landscapers often buy products from mower businesses such as Luber Brothers, Inc. of Oklahoma City, Okla. Businesses such as this one would be an excellent location to distribute brochures and post flyers about Vassar's new product.

Landscapers have a number of professional societies, including the American Landscape Contractors Association, PLANET (Professional Landcare Network) and the American Nursery and Landscape Association. These organizations provide current industry news to all members. Sending information to these associations will enable The Vassar Company to reach contractors across the nation about new product lines and equipment. Half-page magazine advertisements can be placed in any of the trade publications discussed earlier to promote Vassar's soil conditioner.

Landscapers around the country attend landscapers' conventions to become more acquainted with new products and procedures. The Texas Nursery and Landscape Association, for instance, holds an annual nursery and landscape exposition in August to educate consumers and producers alike. The 2011 conference is in Dallas August 18-21; Houston hosts the conference August 17-19, 2012. Surrounding states also have landscapers' associations with annual conferences and trade shows, a full listing of which is in the appendix.

To help The Vassar Company take advantage of these audiences and promote the conditioner, Diller Designs will incorporate pictures, video and testimony into a booth to set up and demonstrate during these conventions and expos. Since the majority of Vassar equipment is sold via distributors, brochures, signs, displays, and other informational items will be designed for dealers to share and display. Being able to have not only the product on display, but also pictures and video showing how it works and in what type of conditions it will perform best, will offer additional opportunities for The Vassar Company to sell their product.

A website page for the soil conditioner will correspond with the existing pages of VassarFarmEquip.com, the company website. This will help the consumer understand what the

product does, as well as provide quality pictures and video to demonstrate the implement's capabilities.

## **Proposed Business Plan**

---

The soil conditioner designed by Diller Designs and manufactured by Vassar has great potential to enter the industry and be a profitable addition to the Vassar product line. One thing to consider as part of the business proposal is whether Vassar will sell the conditioners via existing dealers (most of whom primarily sell farm equipment), add distributors in the landscaping or construction equipment fields, or handle marketing and selling in-house. A number of Vassar's current products could be rebranded as landscaping equipment, if so desired.

As soon as a more detailed plan for the project is finalized, we can begin the economic analysis. For production, we will build a table of the individual pieces necessary to build the prototype. This table could also be useful in comparing potential designs side-by-side on a production cost basis. The table, which is drafted in the appendix, can be revised at any moment, allowing for projections during design testing. Labor costs for production will have to be estimated, but materials plus labor will equal the cost of goods in inventory, and be a reference point for the sales price.

Diller Designs' economic specialist and the management of Vassar will decide if price should be determined by production cost, to insure a predetermined profit margin, or if engineers must control production costs to maintain the profit margin and a predetermined price. Regardless, Vassar has already indicated they want to be priced in the lower half of the market, similar to their position in their other markets.

Another piece of the economic plan that will be integrated into the business plan is a projection of sales. After we have numbers to the sales potential of the product, we can work out larger financial analyses.

## Bibliography

---

(n.d.). Retrieved October 19, 2010, from

<http://www.buyattachmentsdirect.com/skidsteerattachments/landscape-rake/>

*ATI Corporation.* (n.d.). Retrieved October 19, 2010, from Preseeder Landscape Tillers:

<http://abcgroff.com/ic/ati1.htm>

*Bobcat Soil conditioner.* (n.d.) Retrieved November 14, 2010 from Bobcat Company:

[www.bobcat.com/attachments/soil\\_conditioner](http://www.bobcat.com/attachments/soil_conditioner)

*Current State of the Economy and Manufacturing.* June 2010. Retrieved October 20, 2010 from

National Association of Manufacturing: <http://www.nam.org>

*FFC Preparator.* (n.d.). Retrieved 2010 19, October, from Preparator:

[http://paladinbrands.com/product\\_detail.aspx?ID=471](http://paladinbrands.com/product_detail.aspx?ID=471)

*Ground Trades Xchange Forum.* Personal communication. Retrieved Nov 9 2010.

*Harley Power Rakes.* (n.d.). Retrieved October 19, 2010, from Power Rakes:

[http://paladinlightconstructiongroup.com/product\\_detail.aspx?ID=492](http://paladinlightconstructiongroup.com/product_detail.aspx?ID=492)

*Industry Report: 23311 - Land Development in the US.* August 2010. Retrieved October 18, 2010

from IBIS World: [www.ibisworld.com](http://www.ibisworld.com)

*Industry Report: 33311 - Tractors and Agricultural Machinery Manufacturing in the US.* July

2010. Retrieved October 18, 2010 from IBIS World: [www.ibisworld.com](http://www.ibisworld.com)

*Industry Report:42182 - Farm, Lawn, and Garden Equipment Wholesaling in the US.* June 2010.

Retrieved October 18, 2010 from IBIS World: [www.ibisworld.com](http://www.ibisworld.com)

*Industry Report: 44421 - Lawn & Outdoor Equipment Stores in the US.* July 2010. Retrieved

October 18, 2010 from IBIS World: [www.ibisworld.com](http://www.ibisworld.com)

*Industry Report: 56173 - Landscaping Services in the US.* June 2010. Retrieved October 18, 2010

from IBIS World: [www.ibisworld.com](http://www.ibisworld.com)



*John Deere Power Rake.* (n.d.). Retrieved October 19, 2010, from Landscaping Rake Website:

[http://www.deere.com/en\\_US/cfd/construction/deere\\_const/skidsteers/skidsteer\\_attachments/skidsteers\\_powerrake.html](http://www.deere.com/en_US/cfd/construction/deere_const/skidsteers/skidsteer_attachments/skidsteers_powerrake.html)

*John Deere Power Rake Brochure.* (n.d.). Retrieved October 19, 2010, from Power Rake Model PR60-PR72B-PR84B-PR96B:

[http://www.deere.com/en\\_US/cfd/construction/deere\\_const/media/pdf/attachments/DKA\\_PRCWP.pdf](http://www.deere.com/en_US/cfd/construction/deere_const/media/pdf/attachments/DKA_PRCWP.pdf)

*Meet the Nursery and Landscape Industry.* 2009. Retrieved October 21, 2010, from American Nursery and Landscape Association:

<http://www.anla.org/index.cfm?area=&page=Content&CategoryID=148>

*Landscaping Services Industry Overview.* (n.d.) Retrieved October 21, 2010, from Hoovers:

<http://www.hoovers.com/industry/landscaping-services/1908-1.html>

*Nortec Piranha.* (n.d.). Retrieved October 19, 2010, from Piranha Power Rakes:

<http://www.nortecmfg.com/literature.php>

*RockHound.* (n.d.). Retrieved October 19, 2010, from RockHound Landscape Rake:

<http://abcgroff.com/ic/rockh1.htm>

*Woods Alitech Power Rake.* (n.d.). Retrieved October 19, 2010, from Power Rake:

[http://www.woodsequipment.com/skidsteerdetail.aspx?id=13579&ekmense1=41a6502d\\_133\\_155\\_13579\\_1](http://www.woodsequipment.com/skidsteerdetail.aspx?id=13579&ekmense1=41a6502d_133_155_13579_1)

*York Landscape Rake.* (n.d.). Retrieved October 19, 2010, from Thee-Point Hitch Power Rake:

<http://abcgroff.com/ic/york3.htm>

# Appendix

---

## Appendix 1 - Introduction to Problem

Work Breakdown Structure

## Appendix 2 - Competitive Analysis

### A) Industry Analysis

IBIS World 42182 – Equipment Wholesaling

IBIS World 56173 – Landscaping Services

### B) Customers/Buyers

ANLA Website

Hoovers

Current State of the Economy and Manufacturing

Client Phone Conversations

### C) Client Company and Resources

Vassar Product Line

### D) Selected Competitors

FFC Preparator

Harley Power Box Rake

Nortec Piranha

York Landscape Rake

ATI Preseeder Landscape Tiller

Stone Dawg Landscape Rake

RockHound Landscape Rake

Erskine Landscape Rake

Bobcat Soil Conditioner

John Deere Power Rake

### E) Standards and Patents

Standards: SAE J2513

Patents (chronological): 7,117,951

0,132,690

6,497,294

6,223,828

5,564,506

5,261,218

4,516,639

3,071,197

3,055,439

## Appendix 3 - Design Aspects

Physical Testing Budget

Price Estimates from OCT Equipment, Oklahoma City

## Appendix 4 – Spring Project Schedule

Gantt Chart

## Appendix 5 – Proposed Business Plan

Costs of Production Table

## Appendix 6 – Proposed Communications Plan

Landscape Associations, Conferences, and Trade Shows

# Soil Conditioner Design Proposal



# The Team



Jared Kinder  
Colin Lowe  
Jacob Huff  
Paula Smithheisler  
Jace Reed

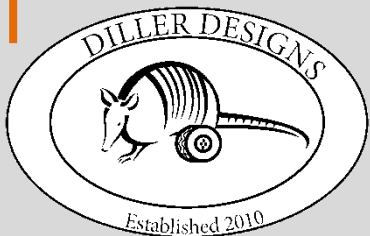

# The Sponsor

## The Vassar Company

- Perkins, Oklahoma
- Established in 1940
- Produces farm equipment
- 6 Distributors including one in Canada distributor

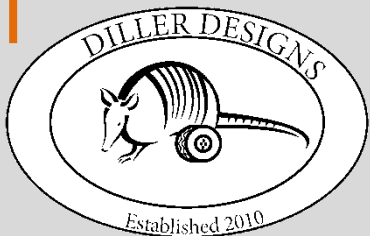
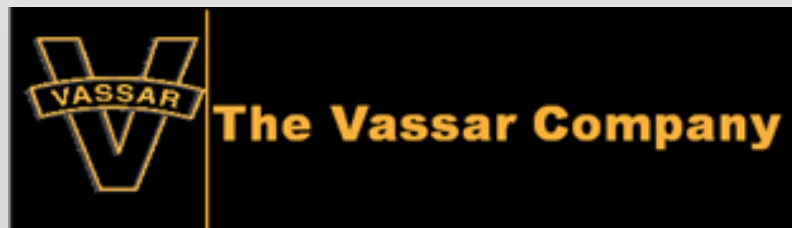

# The Problem

Design a multi-purpose tool for soil conditioning and seedbed preparation that is innovative, but comparable in features and quality to the competition, while priced to sell to the landscape contractors and small construction companies industries.

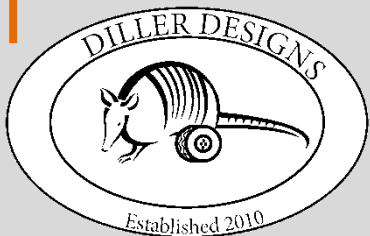

# Product Background

Soil conditioners are used in soil preparation for landscape designers, sod layers, golf turf managers, construction workers and large acre homeowners. Current models specialize in soil tillage, rock and debris collection, and/or soil smoothing/finishing.



# Industry Analysis

Users of this product come primarily from two markets:

- Landscaping Services
- Construction

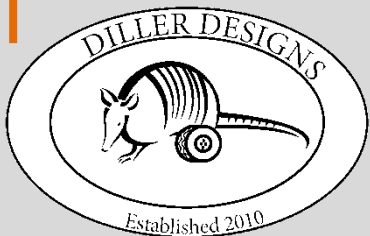



# Landscaping Industry

- Growing industry: easy entry, low start-up costs, large profit potential
- Demand follows national economy
- Equal number of small and large firms:

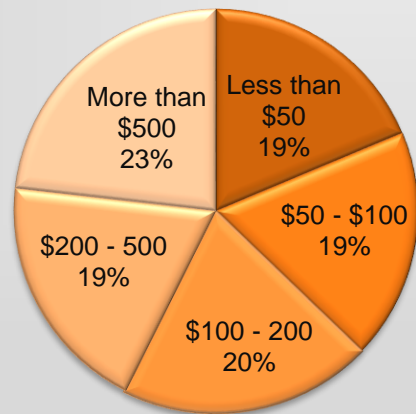

Annual income,  
in thousands of  
dollars

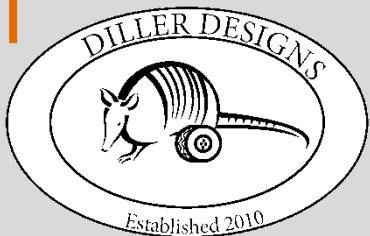

# Construction Industry

- Growing industry: Demand follows national economy
- Single-family homebuilders (86.4% of residential industry) still competitive
- Land developing is projected to increase 9% annually 2011-2015

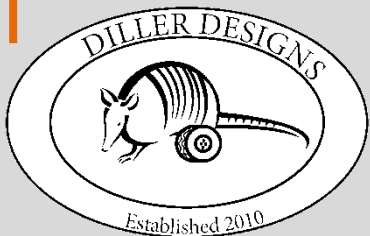

# The Competition

- Harley Power Box Rake
- FFC Preparator
- Stone Dawg Landscape Rake
- York Power Rake
- Bobcat Soil Conditioner



# Competitors



<http://www.abcgroff.com/ic/sslattach.htm>



<http://www.abcgroff.com/ic/pics/ffc1.jpg>

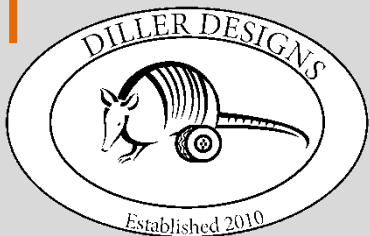

# Competitors



<http://www.wikco.com/pwrrake.html>

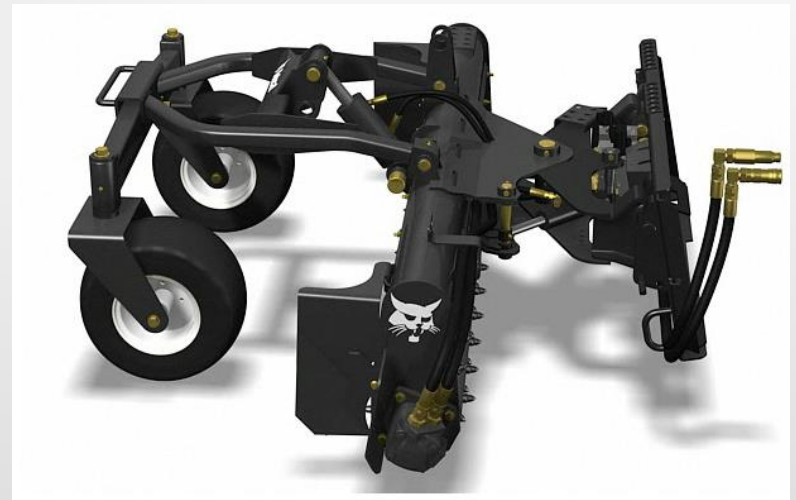

[http://www.usagnet.com/manufacturers/122/soil\\_conditioner.jpg](http://www.usagnet.com/manufacturers/122/soil_conditioner.jpg)

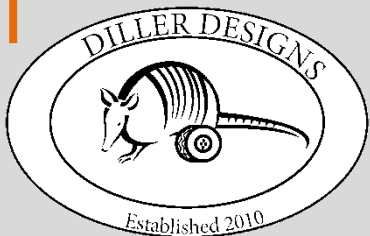

# Testing

## Harley Rake



## FFC Preparator

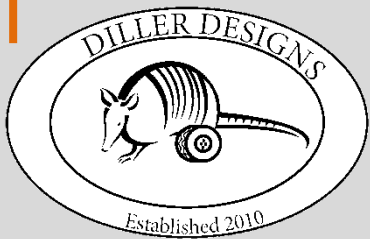

# Testing

Harley Rake



FFC Preparator

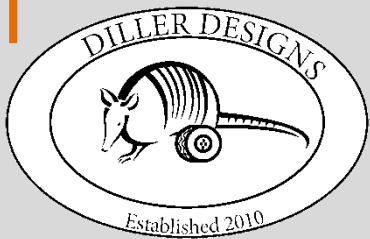

# Engineering Specifications

- Width
  - Overall 6ft
- Durable
  - Over Built
- Skid Steer Auxiliary Ports
- Manual Angle

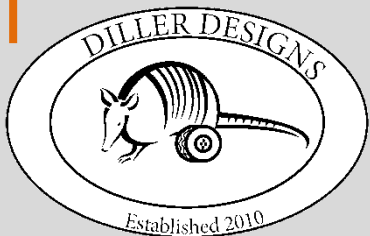



# Design Concepts

## Tooth design

- Number of teeth
- Position/pattern
- Size/length of tooth

## Drum diameter

- Larger diameter keeps bearing out of dirt
- Raises costs



# Design Goals \*summary\*

- Floating Implement
- Direct Drive to Drum
- Bi-directional Hydraulic Motor
- Low Cost

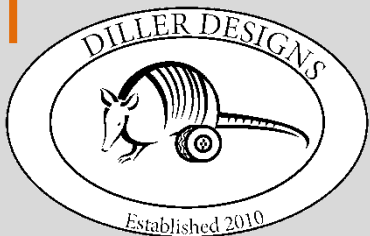
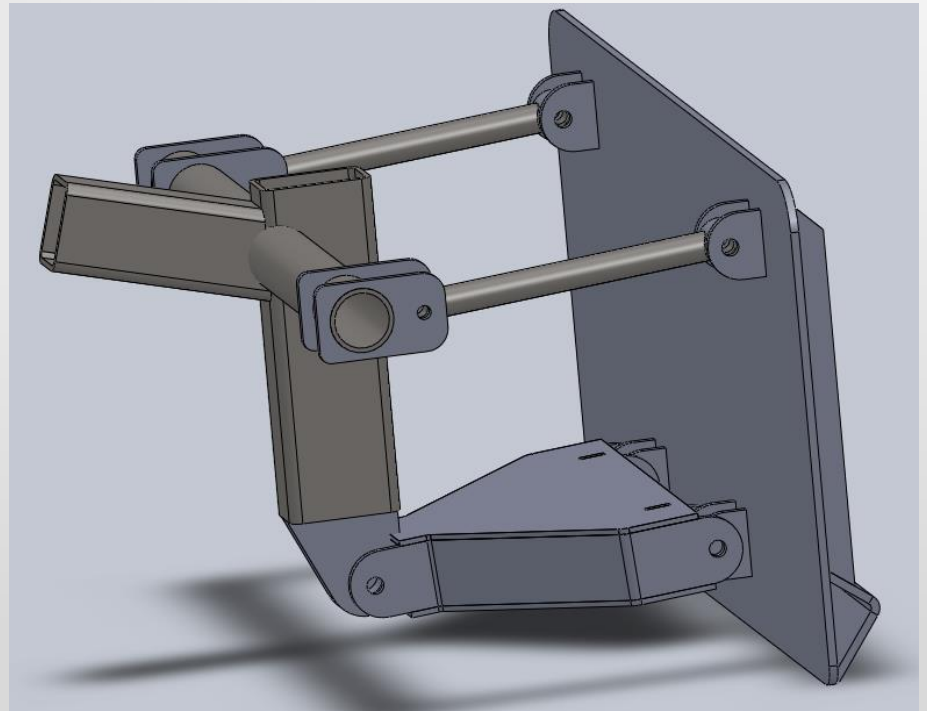

# Spring Design Changes

- Teeth number/pattern
- Chain drive



# Spring Design

- Insert solid works picture of complete proto

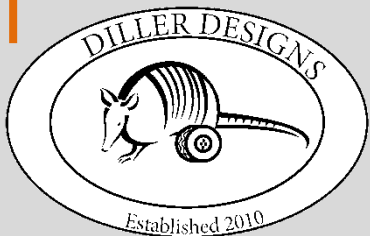

# Production

- Pictures from 4/2

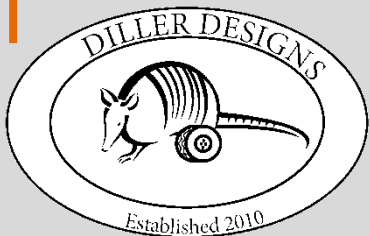

# Testing

- Pictures – videos? Changes made thereof

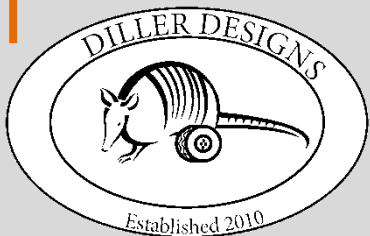

# Finished Prototype

- Pictures, video

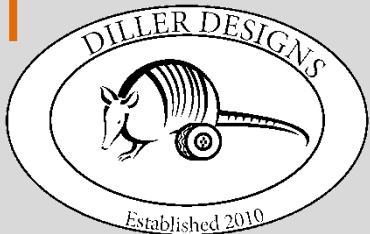

# Communication Plan

- Advertisements at Related Businesses
  - Brochures, flyers, etc
- State Landscape Associations
  - Magazine or newsletter ads
  - Conference/trade show displays
  - Assist dealers with displays

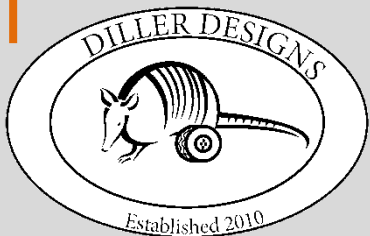



# Trade Shows

- Signs, layout, whatever the hell you feel like



# Website

- Print screen of site with hyperlink

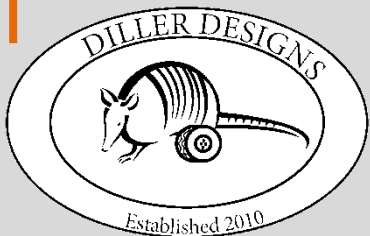

# Business Plan

- Decisions in spring
- Product/brand diversification
- Pricing target
  - MSRP Goal: \$6500-\$7000
- Cost-driven price vs price-driven costs
  - Production table



# Production Table

## Factors of Production

| Item            | units   | used | \$/unit | cost |
|-----------------|---------|------|---------|------|
| <b>Category</b> |         |      |         |      |
| Part X          | each    | x    | x       | x    |
| Part Y          | each    | x    |         | x    |
| Subtotal        |         |      |         | x    |
| <b>Category</b> |         |      |         |      |
|                 | sq feet | x    | x       | x    |
|                 | inches  | x    | x       | x    |
| Subtotal        |         |      |         | x    |
| <b>Category</b> |         |      |         |      |
|                 | each    |      |         | x    |
| Subtotal        |         |      |         | x    |
| <b>Category</b> |         |      |         |      |
|                 | each    |      |         | x    |
| Subtotal        |         |      |         | x    |
| Grand Total     |         |      |         | x    |

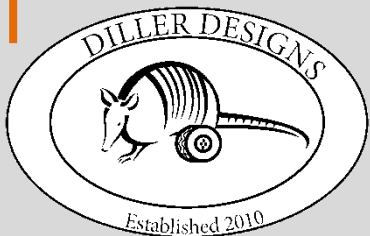



Diller Designs

Oklahoma State University

111 Ag Hall

Stillwater, OK 74078

Phone (405) 706-7165

Fax (405) 744-6059

E-mail:

[jacob.huff@okstate.edu](mailto:jacob.huff@okstate.edu)

The Vassar Company

P.O. Box 609

Perkins, OK 74059

Phone (405) 547-2454

Toll Free (877) 229-8049

Fax (405) 547-2929

E-mail:

[vassar\\_co@vassarfarmequip.com](mailto:vassar_co@vassarfarmequip.com)